



## INSTRUCTION MANUAL

# WIDEBAND RECEIVER IC-RX7

This device complies with Part 15 of the FCC Rules. Operation is subject to the following two conditions: (1) this device may not cause harmful interference, and (2) this device must accept any interference received, including interference that may cause undesired operation.

**WARNING:** MODIFICATION OF THIS DEVICE TO RECEIVE CELLULAR RADIOTELEPHONE SERVICE SIGNALS IS PROHIBITED UNDER FCC RULES AND FEDERAL LAW.

Icom Inc.



---

## FOREWORD

---

Thank you for purchasing this Icom product. The IC-RX7 WIDEBAND RECEIVER is designed and built with Icom's superior technology and craftsmanship. With proper care, this product should provide you with years of trouble-free operation.

We want to take a couple of moments of your time to thank you for making your IC-RX7 your radio of choice, and hope you agree with Icom's philosophy of "technology first." Many hours of research and development went into the design of your IC-RX7.

---

## FEATURES

---

- *Covers 0.150–1300 MHz\* wide frequency range*  
\*Some frequency bands are inhibited according to version
- *Splash-resistance construction (IPX4\*)*  
\*Only when the supplied battery pack (or optional battery case), antenna and jack cover are attached.
- *External power supply operation*
- *1600 memory channels with 26 categories*  
\*Plus 200 auto write channels and 25 program edges
- *Optional PC programming*

---

## IMPORTANT

---

**READ ALL INSTRUCTIONS** carefully and completely before using the receiver.

**SAVE THIS INSTRUCTION MANUAL**— This instruction manual contains important operating instructions for the IC-RX7.

---

## EXPLICIT DEFINITIONS

---

WORD	DEFINITION
⚠ <b>WARNING!</b>	Personal injury, fire hazard or electric shock may occur.
<b>CAUTION</b>	Equipment damage may occur.
<b>NOTE</b>	Recommended for optimum use. No risk of personal injury, fire or electric shock.

**CE** Versions of the IC-RX7 which display the "CE" symbol on the serial number seal, comply with the essential requirements of the European Radio and Telecommunication Terminal Directive 1999/5/EC, and that any applicable Essential Test Suite measurements have been performed.

---

## PRECAUTIONS

---

**⚠ WARNING! NEVER** operate the receiver with an earphone, headphones or other audio accessories at high volume levels. Hearing experts advise against continuous high volume operation. If you experience a ringing in your ears, reduce the volume level or discontinue use.

**⚠ WARNING! NEVER** operate the receiver while driving a vehicle. Safe driving requires your full attention—anything less may result in an accident.

**⚠ WARNING! NEVER** connect the receiver directly to an AC outlet. This may pose a fire hazard or result in an electric shock.

**⚠ CAUTION! NEVER** connect the receiver to a power source other than the specified Icom products. Such a connection will ruin the receiver.

**DO NOT** use or place the receiver in direct sunlight or in areas with temperatures below  $-10^{\circ}\text{C}$  ( $+14^{\circ}\text{F}$ ) or above  $+60^{\circ}\text{C}$  ( $+140^{\circ}\text{F}$ ).

Place the unit in a secure place to avoid inadvertent use by children.

**DO NOT** use of chemical agents such as benzene or alcohol when cleaning, as they can damage the receiver's surfaces.

**KEEP** away from heavy rain, and never immerse the IC-RX7 in the water. The receiver meets IPX4\* requirements for splash resistance. However, once the receiver has been dropped, splash resistance cannot be guaranteed because of possible damage to the receiver's case or waterproof seal.

\*Only when the supplied battery pack (or optional battery case), antenna and jack cover are attached.

**NEVER** operate or touch the receiver with wet hands. This may result in an electric shock or damage the receiver.

Even when the receiver power is OFF, a slight current still flows in the circuits. Remove the battery pack or batteries from the receiver while not using it for a long time. Otherwise, the installed battery pack or batteries will become exhausted, and will need to be recharged or replaced.

**RESPECT** other people's privacy. Information overheard but not intended for you cannot lawfully be used in any way.

*For U.S.A. only*

**CAUTION!:** Changes or modifications to this device, not expressly approved by Icom Inc., could void your authority to operate this device under FCC regulations.

## FCC INFORMATION

### • FOR CLASS B UNINTENTIONAL RADIATORS:

This equipment has been tested and found to comply with the limits for a Class B digital device, pursuant to part 15 of the FCC Rules. These limits are designed to provide reasonable protection against harmful interference in a residential installation. This equipment generates, uses and can radiate radio frequency energy and, if not installed and used in accordance with the instructions, may cause harmful interference to radio communications. However, there is no guarantee that interference will not occur in a particular installation. If this equipment does cause harmful interference to radio or television reception, which can be determined by turning the equipment off and on, the user is encouraged to try to correct the interference by one or more of the following measures:

- Reorient or relocate the receiving antenna.
- Increase the separation between the equipment and receiver.
- Connect the equipment into an outlet on a circuit different from that to which the receiver is connected.
- Consult the dealer or an experienced radio/TV technician for help.

## SUPPLIED ACCESSORIES

The following accessories are supplied with the receiver.

① Hand strap .....	1
② Antenna .....	1
③ Belt clip .....	1
④ Battery pack (BP-244) .....	1
⑤ Battery charger* (BC-149A/D) .....	1

(The shape of the BC-149A and BC-149D are different.)

\*Not supplied with some versions.

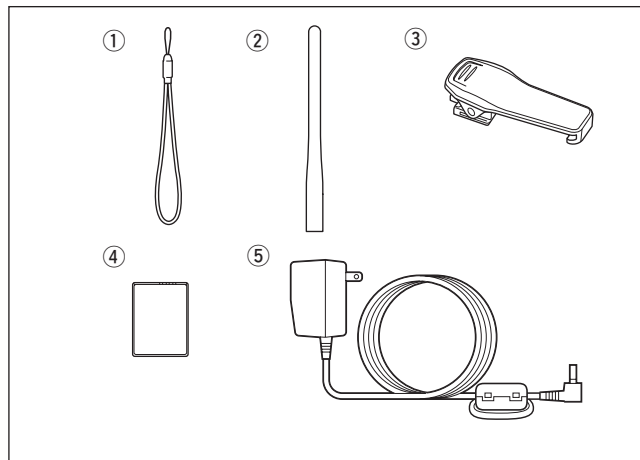



---

## OPERATING THEORY

---

Electromagnetic radiation which has frequencies of 20,000 Hz (20 kHz\*) and above is called radio frequency (RF) energy because it is useful in radio transmissions. The IC-RX7 receives RF energy from 0.150 MHz\* to 1300 MHz\* and converts it into audio frequency (AF) energy which in turn actuates a loudspeaker to create sound waves. AF energy is in the range of 20 to 20,000 Hz.

\*kHz is an abbreviation of kilohertz or 1000 hertz, MHz is abbreviation of megahertz or 1,000,000 hertz, where hertz is a unit of frequency.

---

## OPERATING NOTES

---

The IC-RX7 may receive its own oscillated frequency, resulting in no reception or only noise reception, on some frequencies.

The IC-RX7 may receive interference from extremely strong signals on different frequencies or when using an external high-gain antenna.

Icom, Icom Inc. and the  ICOM logo are registered trademarks of Icom Incorporated (Japan) in the United States, the United Kingdom, Germany, France, Spain, Russia and/or other countries.

Microsoft, Windows and Windows Vista are either registered trademarks or trademarks of Microsoft Corporation in the United States and/or other countries.

---

# TABLE OF CONTENTS

---

FOREWORD .....	i	■ Setting squelch level .....	15
FEATURES .....	i	■ Monitor function .....	15
IMPORTANT .....	i	■ Operating mode selection .....	16
EXPLICIT DEFINITIONS .....	i	■ Receiving mode selection .....	19
PRECAUTIONS .....	ii	<b>5 FREQUENCY SETTING .....</b>	<b>20–23</b>
FCC INFORMATION .....	iii	■ Setting a frequency .....	20
SUPPLIED ACCESSORIES .....	iii	■ Setting a tuning step .....	23
OPERATING THEORY .....	iv	<b>6 SEARCH AND SCAN OPERATIONS .....</b>	<b>24–48</b>
OPERATING NOTES .....	iv	■ Search and scan types .....	24
TABLE OF CONTENTS .....	v–vii	■ Full search .....	26
<b>1 ACCESSORY ATTACHMENT .....</b>	<b>1–3</b>	■ Basic search .....	26
■ Antenna .....	1	■ Band search .....	27
■ Belt clip .....	1	■ Program search .....	28
■ Hand strap .....	2	■ Program link search .....	29
■ Battery installation .....	2	■ Search edges programming .....	30
■ Optional battery case .....	3	■ Program link programming .....	32
<b>2 PANEL DESCRIPTION .....</b>	<b>4–9</b>	■ Auto write search .....	34
■ Front, top and side panels .....	4	■ Skip search .....	36
■ Function display .....	7	■ Priority watch .....	37
<b>3 BATTERY CHARGING .....</b>	<b>10–13</b>	■ Other SEARCH menu items .....	40
■ Caution .....	10	■ Link scan .....	41
■ Charging .....	12	■ All scan .....	42
■ Battery information .....	13	■ Category scan .....	42
■ External DC power operation .....	13	■ Group scan .....	43
<b>4 BASIC OPERATION .....</b>	<b>14–19</b>	■ Weather channel operation .....	44
■ Power ON .....	14	■ Skip setting for scanning .....	45
■ Setting audio volume .....	14	■ Priority scan .....	47
		■ Other SCAN menu items .....	48

# TABLE OF CONTENTS

## 7 MEMORY PROGRAMMING .....49–58

- General description.....49
- Memory channel programming.....50
- Memory channel selection.....55
- Copying memory contents.....56
- Changing memory contents.....57
- Clearing memory contents.....58

## 8 MENU SCREEN OPERATION .....59–72

- General .....59
- Menu list .....60
- MODE/TS/TONE menu items.....62
  - ◇ Duplex direction (DUPLEX) .....62
  - ◇ Offset frequency (OFFSET FREQ).....62
  - ◇ Tuning step (TS) .....63
  - ◇ Receiving mode (MODE).....63
  - ◇ Tone squelch/DTCS squelch setting (TONE).....64
  - ◇ Tone squelch frequency (TSQL FREQ).....64
  - ◇ DTCS code (DTCS CODE).....65
  - ◇ DTCS polarity (DTCS POLARITY) .....65
  - ◇ Voice squelch control (VSC) .....65
- SETTING menu items.....66
  - ◇ AM antenna selection (AM ANTENNA) .....66
  - ◇ FM antenna selection (FM ANTENNA).....66
  - ◇ RF gain (RF GAIN) .....67
  - ◇ Auto power OFF (AUTO POWER OFF).....67
  - ◇ Auto power ON (AUTO POWER ON) .....67
  - ◇ Power save (POWER SAVE) .....67
  - ◇ Dial acceleration (DIAL SPEED-UP) .....68
  - ◇ Key lock type (LOCK) .....68
  - ◇ CI-V setting (CI-V SET) .....69

- CI-V address (ADDRESS).....69
- CI-V baud rate (BAUD RATE).....69
- CI-V transceive (TRANSCIVE).....69
- SOUNDS menu items.....70
  - ◇ Key-touch beep (KEY-TOUCH BEEP) .....70
  - ◇ Beep output level (BEEP LEVEL).....70
  - ◇ AF filter (AF FILTER) .....70
  - ◇ Tone control (TONE CONTROL) .....71
    - Bass level (BASS) .....71
    - Treble level (TREBLE) .....71
- DISPLAY menu items .....72
  - ◇ Display backlighting (BACKLIGHT) .....72
  - ◇ LCD contrast (LCD CONTRAST) .....72
  - ◇ Opening logo (OPENING LOGO).....72
  - ◇ Font size (FONT SIZE) .....72

## 9 OTHER FUNCTIONS .....73–87

- Antenna selection .....73
- RF gain .....74
- Attenuator function.....75
- Lock function.....75
- Duplex operation.....76
- [DIAL] function assignment.....77
- Tone/DTCS squelch operation .....78
- Tone squelch frequency/DTCS code setting .....80
- DTCS polarity setting.....81
- Tone search .....82
- Beep tones.....83
- Dial speed acceleration .....83
- Power save .....83
- Auto power OFF.....84

- 1
- 2
- 3
- 4
- 5
- 6
- 7
- 8
- 9
- 10
- 11
- 12
- 13
- 14

---

# TABLE OF CONTENTS

---

■ Auto power ON .....	84
■ Display backlighting .....	84
■ Font size .....	84
■ LCD contrast.....	85
■ Voice squelch control .....	85
■ Cloning function.....	86
■ Resetting.....	87
<b>10 CONTROL COMMAND.....</b>	<b>88–89</b>
■ General .....	88
■ Data format.....	88
■ Command table .....	88
<b>11 TROUBLESHOOTING.....</b>	<b>90</b>
<b>12 SPECIFICATIONS.....</b>	<b>91</b>
<b>13 OPTIONS .....</b>	<b>92</b>
<b>14 CE .....</b>	<b>93–94</b>
<b>INDEX .....</b>	<b>95–98</b>

## ■ Antenna

Screw down the antenna as shown below.

**NEVER** carry the receiver by holding the antenna.

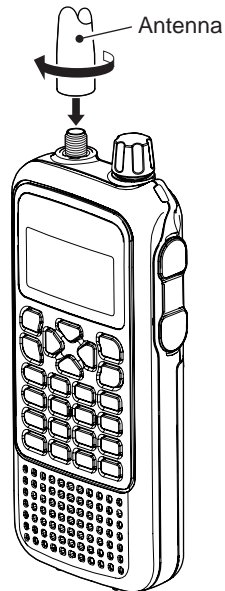

## ■ Belt clip

Slide the supplied belt clip on the receiver's rear panel until it clicks into place.

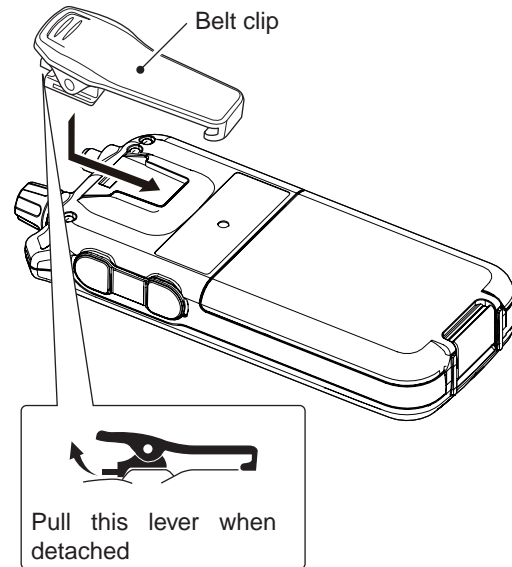

### ✓ *For your information*

Some high quality third party antennas may increase receiver performance. An optional AD-92SMA ANTENNA CONNECTOR ADAPTER is available to connect an antenna with a BNC connector.

# 1 ACCESSORY ATTACHMENT

## ■ Hand strap

Slide the hand strap through the loop on the right top of the receiver as illustrated below to facilitate carrying the receiver.

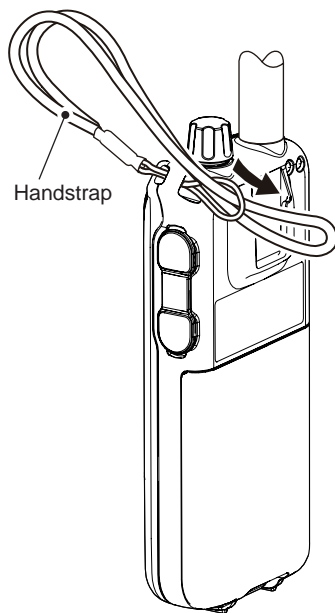

## ■ Battery installation

Install the Li-Ion battery pack (BP-244) or optional battery case (BP-262) as follows.

① Remove the battery cover from the receiver.

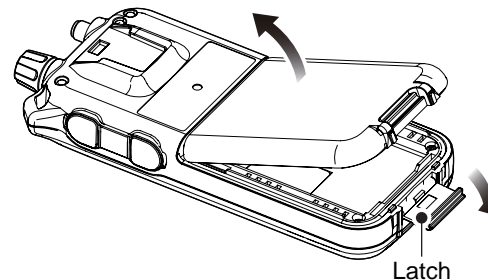

② Install the Li-Ion battery pack (BP-244).

- Be sure to observe the correct direction.
- Charge the Li-Ion battery pack before use. (p. 12)

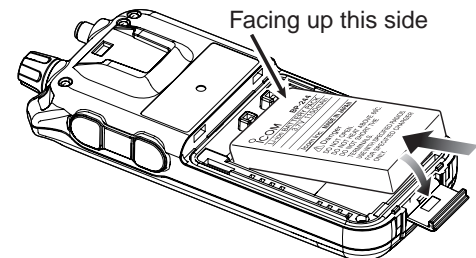

- ③ Attach the battery cover to the receiver.

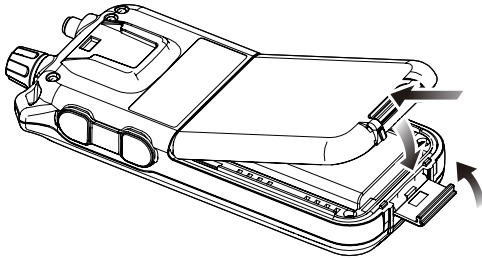

Keep battery contacts clean. It's a good idea to clean battery terminals once a week.

• **BP-262 installation**

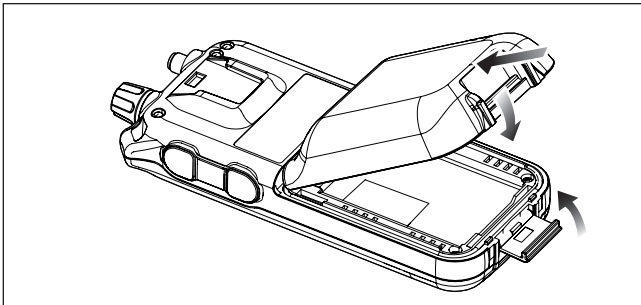

## Optional battery case

- Install 3 × LR6 (AA) size alkaline batteries into the optional BP-262 BATTERY CASE.
- Be sure to observe the correct polarity.

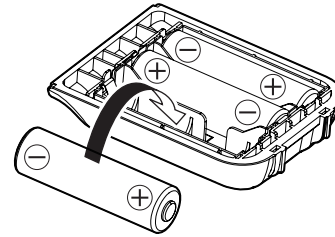

### ◇ Battery information

The batteries may seem to have low capacity when used in low temperatures such as  $-10^{\circ}\text{C}$  ( $+14^{\circ}\text{F}$ ) or below. Keep the battery case or pack warm in this case.

### ◇ Battery replacement

When the batteries become exhausted, the battery indicator “” appears then the receiving audio may be distorted. In these cases, replace all batteries with new, same brand, alkaline batteries.

## ■ Front, top and side panels

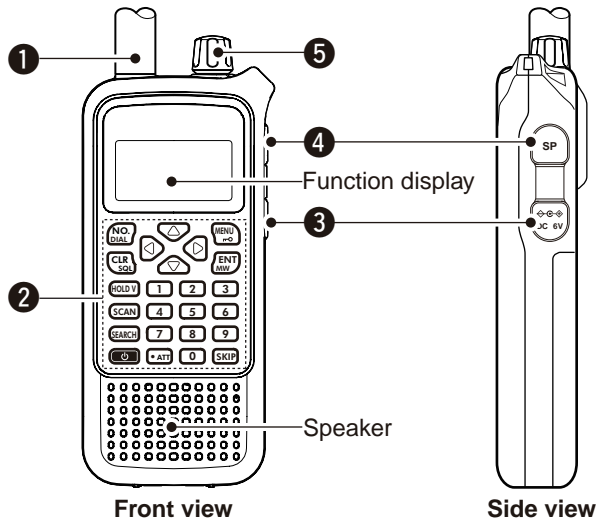

### ① ANTENNA CONNECTOR (p. 1)

Connects the supplied antenna.

- An optional AD-92SMA adapter (p. 92) is available for connecting an antenna with a BNC connector.

### ② KEYPAD (pgs. 5–7)

### ③ EXTERNAL DC IN JACK [DC 6V]

Connects a battery charger or an optional CP-18A/E cigarette lighter cable for both charging the installed rechargeable battery pack and operating.

**Keep** the jack cover attached when jacks are not in use to protect contacts from dust and moisture.

### ④ EXTERNAL SPEAKER/CLONE JACK [SP]

Connect a clone cable, optional speaker or head phone, if desired.

See page 92 for a list of available options.

- ➔ Connect an optional head phone or earphone.

The internal speaker will not function when any external equipment is connected.

- ➔ Connects to a PC using an optional OPC-478/UC CLONING CABLE for cloning. Cloning allows you to quickly and easily transfer the programmed contents between the IC-RX7 and the connected PC. (p. 86)
- ➔ Connect an optional CT-17 for remote control operation. (p. 89)

### ⑤ CONTROL DIAL [DIAL]

- ➔ During VFO mode or search holding state, rotate to tune the operating frequency. (pgs. 18, 22)
- ➔ During memory mode or scan holding state, rotate to select the memory channel. (pgs. 18, 55)
- ➔ During searching or scanning, changes the searching or scanning direction. (p. 18)
- ➔ During menu screen operation, rotate to select the set items or values. (p. 59)
- ➔ While monitor function is active, rotate to set the squelch level. (p. 15)

▨ The assigned function for [DIAL] and [Δ]/[▽] can be exchanged by pushing and holding [NO. DIAL].



## KEYPAD

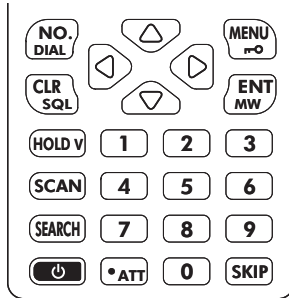

### NUMERAL KEYS [0] to [9]

- 0** ➔ Enter the frequency in VFO mode or memory programming state. (pgs. 20, 21, 55)
- ➔ After pushing **[NO. DIAL]**, select the memory name number directly in scan mode. (p. 55)
- 9** ➔ After pushing **[\* ATT]**, turn the scan link setting ON and OFF in scan mode. (p. 51)

### NUMBER/DIAL KEY [NO. DIAL]

- NO. DIAL** ➔ Push this key then push numeral keys to select the memory channel name (number) in the memory category directly. (p. 55)
- ➔ Push and hold for 1 sec. to exchange the assigned functions between **[DIAL]** and **[△]/[▽]**. (p. 77)

### CLEAR/SQUELCH KEY [CLR SQL]

- CLR SQL** ➔ Aborts numeral key input. (p. 20)
- ➔ Push to return to previous operating condition while memory channel programming or while in menu screen operation. (p. 59)
- ➔ Push and hold for 1 sec. to open the squelch temporarily and monitor the operating frequency. (p. 15)
- ➔ After pushing and holding this key for 1 sec., rotate **[DIAL]** to adjust the squelch level. (p. 15)

### HOLD/VFO KEY [HOLD V]

- HOLD V** ➔ Push to stop searching or scanning temporarily, and push again to return previous condition. (p. 18)
- ➔ Push and hold for 1 sec. to select VFO mode. (p. 16)

### SCAN KEY [SCAN]

- SCAN** ➔ Push to start a scan. (p. 18)
- ➔ Push and hold for 1 sec. to enter SCAN menu.

### SEARCH KEY [SEARCH]

- SEARCH** ➔ Push to start a search. (p. 26)
- ➔ Push and hold for 1 sec. to enter SEARCH menu.

(Continue to the next page...)

## 2 PANEL DESCRIPTION

### POWER KEY [ ]



Push for 1 sec. to turn the receiver power ON or OFF. (p. 14)

### ATTENUATOR KEY [ ATT ]



- ➔ During VFO mode, push to input MHz digit for frequency entry. (pgs. 20, 21)
- ➔ During link scan, push this key then push numeral keys to turn the link setting ON and OFF. (p. 51)
  - Direct key number 0 to 9 can be selected by numeral key only.
- ➔ Push and hold for 1 sec. to turn the attenuator function ON and OFF. (p. 75)

### SKIP KEY [ SKIP ]



- ➔ During scan holding state, push to set the memory channel as the following skip channel in order. (p. 46)
  - Skip channel — “SKIP” appears.
  - Frequency skip channel — “PSKIP” appears.
  - Non-skip channel — no skip indicator appears.
- ➔ During search operation, push and hold for 1 sec. to program a paused frequency as a skip frequency. (p. 36)
- ➔ During link scan operation, push and hold for 1 sec. to select the group skip setting ON and OFF. (p. 46)

### ENTER/MEMORY WRITE KEY [ ENT MW ]



- ➔ During VFO mode, search holding state or scan mode, push and hold for 1 sec. to enter memory programming state. (pgs. 50, 56, 57)
- ➔ During search operation, push and hold for 1 sec. to turn the auto write search function ON and OFF. (p. 34)
- ➔ During memory programming state, push and hold for 1 sec. to write the operating frequency into the selected memory channel.
- ➔ During menu screen operation or memory programming state, push to enter to the selected set items, etc. (p. 59)

### MENU/LOCK KEY [ MENU ]



- ➔ Push to select menu screen indication ON. (p. 59)
- ➔ Push and hold for 1 sec. to toggle the lock function ON and OFF. (p. 75)

**LEFT/RIGHT KEY [◀]/[▶]**



➤ During VFO mode or search mode, push to select the operating frequency band. (p. 18)



➤ During VFO mode, push and hold for 1 sec. to select and toggle 1 MHz and 10 MHz tuning steps. (p. 22)

➤ During scan mode, push to select the group. (p. 18)

➤ During scan mode, push and hold for 1 sec. to select the category. (p. 18)

➤ During menu screen operation, push to select the upper layer or lower layer. (p. 59)

**UP/DOWN/VOLUME CONTROL KEY [▲]/[▼]**



➤ Adjust audio volume level. (p. 14)

➤ During menu screen operation, push to select the set items or values. (p. 59)



The function of tuning control and volume control can be traded. See page 77 for details.

**■ Function display**

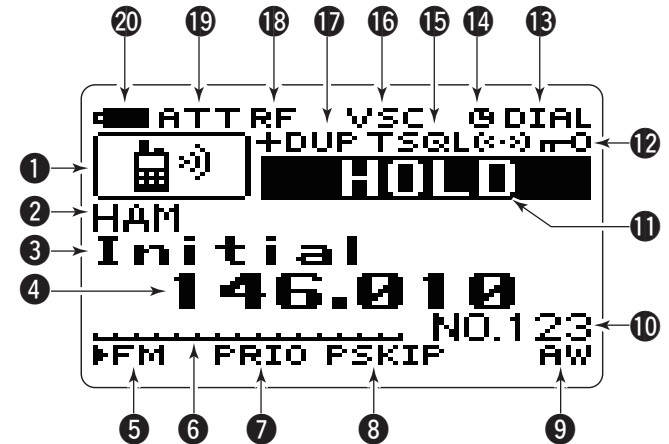

**① ICON INDICATOR (p. 52)**

Displays a variety of icon.

- Following 23 icons are available for category programming, TRUCK, BUS, CAR, RACE CAR, TAXI, MOTORCYCLE, TRAIN, SHIP, YACHT, AIRCRAFT, GLIDER, HAM, HAM HH, RADIO, TV, EMERGENCY, FIRE, WEATHER, HUMAN, ANIMAL, BUILDING, HOUSE and PROGRAM SEARCH.

(Continue to the next page...)

## 2 PANEL DESCRIPTION

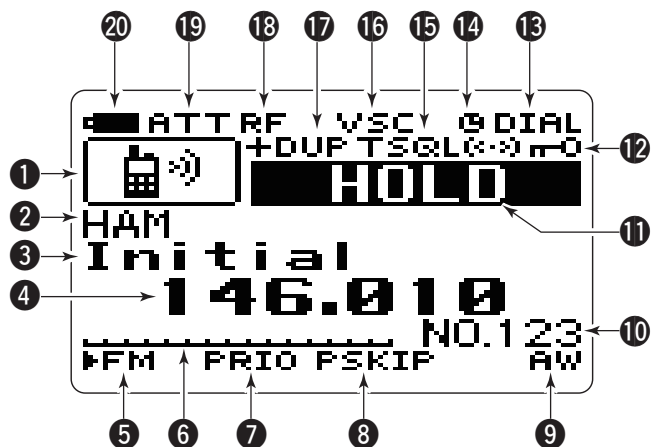

- 2 CATEGORY INDICATOR** (p. 52)  
During scan mode, the programmed memory category is displayed.
- 3 MEMORY GROUP INDICATOR** (p. 53)  
During scan mode, the programmed memory group is displayed.

### 4 FREQUENCY READOUT

Displays a variety of information, such as operating frequency, memory names.

- The decimal point blinks during search.

### 5 RECEIVING MODE INDICATOR

 (p. 19)

Shows the selected receiving mode.

- FM, WFM and AM are available, depending on operating band.
- "►" appears when auto mode is selected for USA version.

### 6 S-METER

Shows the relative signal strength while receiving signals.

### 7 PRIORITY WATCH INDICATOR

 (pgs. 38, 39, 47)

Appears when priority watch is in use.

### 8 SKIP INDICATOR

- ➔ "SKIP" appears when the selected memory channel is set as a skip channel. (pgs. 46, 55)
- ➔ "PSKIP" blinks during skip search operation. (p. 36)

### 9 AUTO WRITE SEARCH INDICATOR

Blinks during auto write search operation. (p. 34)

### 10 MEMORY NUMBER INDICATOR

Shows the selected memory number. (pgs. 54, 55)









- This number is assigned to memory name and use this number for memory management in each memory category.  
Memory organization: Category ► Group ► Name ► Channel
- This number is assigned to memory channel for basic search.  
The basic search can be re-programmed by optional CS-RX7.

### 11 STATUS INDICATOR

Shows the receiver's status such as "HOLD," "SCAN," "SEARCH" or "MEMORY."

- ⑫ **KEY LOCK INDICATOR** (p. 75)  
Appears when the key lock function is activated.
- ⑬ **DIAL STATUS INDICATOR** (p. 77)
  - “DIAL” appears when [DIAL] is assigned as frequency control.
    - In this case, [△]/[▽] keys are activate for volume control.
  - “VOL” appears when [DIAL] is assigned as volume control.
    - In this case, [△]/[▽] keys are activate for frequency control.
- ⑭ **AUTO POWER OFF INDICATOR** (p. 84)  
Appears when the auto power OFF function is in use.
- ⑮ **STONE SQUELCH INDICATOR** (pgs. 78, 79)  
Available only when FM mode is selected.
  - “TSQL” appears while the tone squelch function is in use.
  - “TSQL-R” appears while the reverse\* tone squelch function is in use.
  - “DTCS” appears while the DTCS squelch function is in use.
  - “DTCS-R” appears while the reverse\* DTCS squelch function is in use.
  - “((•))” appears with the “TSQL” or “DTCS” indicator while the pocket beep function (with CTCSS or DTCS) is in use.

\* Reverse tone squelch or reverse DTCS squelch opens when the signal is received with unmatched tone or DTCS.
- ⑯ **VOICE SQUELCH CONTROL INDICATOR** (p. 85)  
Appears when VSC (Voice squelch control) function is in use.

- ⑰ **DUPLEX INDICATOR** (pgs. 76, 77)  
“+DUP” appears when plus duplex, “-DUP” appears when minus duplex is selected.
- ⑱ **RF GAIN INDICATOR** (p. 74)  
“RF” appears when the RF gain is adjusted other than “MAX.”
- ⑲ **ATTENUATOR INDICATOR** (p. 75)  
Appears when the RF attenuator is in use.
- ⑳ **BATTERY INDICATOR** (p. 13)
  - **When BP-244 is attached**
    - “” (battery indicator) appears when the battery pack has ample capacity.
    - “” appears when the battery pack is nearing exhaustion, and it must be charged.
    - “” blinks before the battery pack is exhausted.
    - The indicator shows “,” “” and “ (disappears)” in sequence while charging the attached battery pack, and indicator disappears when completely charged.
  - **When BP-262 is attached**
    - “” (battery indicator) appears when the installed batteries have ample capacity.
    - “” appears when the installed batteries are nearing exhaustion.
    - “” blinks before the installed batteries are exhausted.

## ■ Caution

Misuse of Lithium-Ion batteries may result in the following hazards: smoke, fire, or the battery may rupture. Misuse can also cause damage to the battery or degradation of battery performance.

- ⚠ **DANGER!** Use and charge only specified Icom battery packs with Icom radios. Only Icom battery packs are tested and approved for use with Icom radios. Using third-party or counterfeit battery packs may cause smoke, fire, or cause the battery to burst.
- ◇ **Battery caution**
  - ⚠ **DANGER! DO NOT** hammer or otherwise impact the battery. Do not use the battery if it has been severely impacted or dropped, or if the battery has been subjected to heavy pressure. Battery damage may not be visible on the outside of the case. Even if the surface of the battery does not show cracks or any other damage, the cells inside the battery may rupture or catch fire.
  - ⚠ **DANGER! NEVER** use or leave battery pack in areas with temperatures above +60°C (+140°F). High temperature buildup in the battery, such as could occur near fires or stoves, inside a sun heated car, or in direct sunlight may cause the battery to rupture or catch fire. Excessive temperatures may also degrade battery performance or shorten battery life.
- ⚠ **DANGER! DO NOT** expose the battery to rain, snow, seawater, or any other liquids. Do not charge or use a wet battery. If the battery gets wet, be sure to wipe it dry before using.
- ⚠ **DANGER! NEVER** incinerate a used battery pack since internal battery gas may cause it to rupture, or may cause an explosion.
- ⚠ **DANGER! NEVER** solder the battery terminals, or **NEVER** modify the battery pack. This may cause heat generation, and the battery may burst, emit smoke or catch fire.
- ⚠ **DANGER!** Use the battery only with the receiver for which it is specified. Never use a battery with any other equipment, or for any purpose that is not specified in this instruction manual.
- ⚠ **DANGER!** If fluid from inside the battery gets in your eyes, blindness can result. Rinse your eyes with clean water, without rubbing them, and see a doctor immediately.
- **WARNING!** Immediately stop using the battery if it emits an abnormal odor, heats up, or is discolored or deformed. If any of these conditions occur, contact your Icom dealer or distributor.
- **WARNING!** Immediately wash, using clean water, any part of the body that comes into contact with fluid from inside the battery.

- **WARNING! NEVER** put the battery in a microwave oven, high-pressure container, or in an induction heating cooker. This could cause a fire, overheating, or cause the battery to rupture.
- **CAUTION!** Always use the battery within the specified temperature range for the receiver ( $-10^{\circ}\text{C}$  to  $+60^{\circ}\text{C}$ ;  $+14^{\circ}\text{F}$  to  $+140^{\circ}\text{F}$ ) and the battery itself ( $-20^{\circ}\text{C}$  to  $+60^{\circ}\text{C}$ ;  $-4^{\circ}\text{F}$  to  $+140^{\circ}\text{F}$ ). Using the battery out of its specified temperature range will reduce the battery's performance and battery life. Please note that the specified temperature range of the battery may exceed that of the receiver. In such cases, the receiver may not work properly because it is out of its operating temperature range.
- **CAUTION!** Shorter battery life could occur if the battery is left fully charged, completely discharged, or in an excessive temperature environment (above  $+50^{\circ}\text{C}$ ;  $+122^{\circ}\text{F}$ ) for an extended period of time. If the battery must be left unused for a long time, it must be detached from the radio after discharging. You may use the battery until the battery indicator shows half-capacity, then keep it safely in a cool dry place with the below temperature range.
  - $20^{\circ}\text{C}$  ( $-4^{\circ}\text{F}$ ) to  $+50^{\circ}\text{C}$  ( $+122^{\circ}\text{F}$ ) (within a month).
  - $20^{\circ}\text{C}$  ( $-4^{\circ}\text{F}$ ) to  $+35^{\circ}\text{C}$  ( $+95^{\circ}\text{F}$ ) (within three months).
  - $20^{\circ}\text{C}$  ( $-4^{\circ}\text{F}$ ) to  $+20^{\circ}\text{C}$  ( $+68^{\circ}\text{F}$ ) (within a year).

#### ◇ Charging caution

- **⚠ DANGER! NEVER** charge the battery pack in areas with extremely high temperatures, such as near fires or stoves, inside a sun heated car, or in direct sunlight. In such environments, the safety/protection circuit in the battery will activate, causing the battery to stop charging.
- **WARNING! DO NOT** charge or leave the battery in the receiver beyond the specified time for charging. If the battery is not completely charged by the specified time, stop charging and remove the external DC power from the receiver. Continuing to charge the battery beyond the specified time limit may cause a fire, overheating, or the battery may rupture.
- **CAUTION! DO NOT** charge the battery outside of the specified temperature range:  $+5^{\circ}\text{C}$  to  $+35^{\circ}\text{C}$  ( $+41^{\circ}\text{F}$  to  $+95^{\circ}\text{F}$ ). Icom recommends charging the battery at  $+25^{\circ}\text{C}$  ( $+77^{\circ}\text{F}$ ). The battery may heat up or rupture if charged out of the specified temperature range. Additionally, battery performance or battery life may be reduced.

### 3 BATTERY CHARGING

## ■ Charging

Prior to using the receiver for the first time, the battery pack must be fully charged for optimum life and operation.

### ◇ Battery indicator and charging indicator

When the receiver's power is OFF, the charging indicator shows " [ ] ", " [ ] " and " [ ] " in sequence with "Charging..." while charging, and indicator disappears when completely charged.

When the receiver's power is ON, the battery indicator shows " [ ] ", " [ ] " and " [ ] (disappears)" in sequence while charging, and indicator disappears when completely charged.

### ◇ Charging note

- Be sure to turn the receiver power OFF. Otherwise the battery pack will not be charged completely or takes longer to charge time periods.
- External DC power operation becomes possible when using an optional CP-18A/E. The attached battery pack is also charged simultaneously.
- If your battery pack seems to have no capacity even after being charged, fully charge the battery pack again. If the battery pack still does not retain a charge (or very little), a new battery pack must be purchased.

- ① Insert the battery pack (BP-244) into the receiver. (p. 2)
- ② Plug the battery charger (BC-149A/D\*) into an AC outlet; or the optional CP-18A/E into a cigarette lighter socket.  
\* Not supplied with some versions.
- ③ Turn OFF the receiver, then insert the adapter plug into [DC 6V] of the receiver.

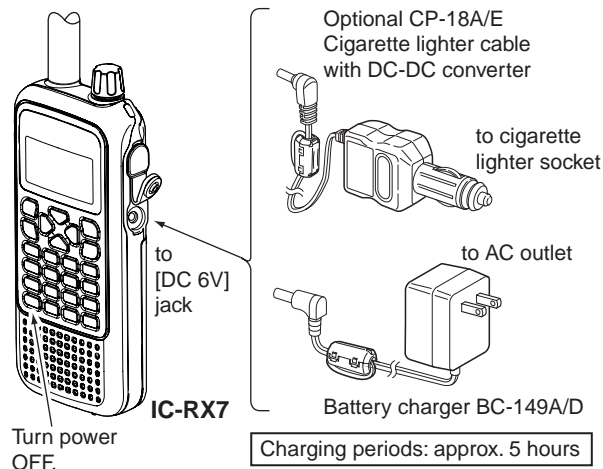

**CAUTION:** BE SURE to disconnect the CP-18A/E from the cigarette lighter socket when charging is finished. A slight current drain from the CP-18A/E will eventually drain the vehicle's battery.



## ■ Battery information

### ◇ Battery life

The receiver operates with the BP-244 Li-ion battery pack or BP-262 Battery case as follows.

- BP-244: Approx. 8 hours \*1
- BP-262: Approx. 16.5 hours \*1,\*2



(Continuous receiving at rated AF output with backlight OFF)

\*1 Operating time may differ depending on the operating conditions.



\*2 Operating time may differ depending on the installed batteries.

Even when the receiver power is OFF, a small current still flows in the receiver. Remove the battery pack or case from the receiver when not using it for a long time. Otherwise, the battery pack or installed batteries will become exhausted.

### ◇ Battery indicator

The battery indicator, “” or “” appears when the BP-244 or BP-262 is attached to the receiver, and when the battery indicator, “”, blinks before the BP-244 or BP-262 is exhausted.

The battery indicator does not appear during turning power ON when the BP-244 is still connected to the battery charger or an external DC power source.

Indication	Battery condition
	The battery pack or case has ample capacity.
	The battery pack or case is nearing exhaustion. Charging (BP-244) or replacing batteries (BP-262) is necessary.

## ■ External DC power operation

An optional cigarette lighter cable (CP-18A/E; for 12 V cigarette lighter socket) can be used for external power operation.

### ◇ Operating note

- **BE SURE** to use **CP-18A/E** when connecting a regulated 12 V DC power supply. Use an external DC-DC converter to connect the receiver through optional CP-18A/E to a 24 V DC power source.
- The receiver may receive switching noise from the connected switching DC-DC converter (or power supply) depending on the operating frequencies and/or using antenna, etc.
- The power save function is deactivated automatically during external DC power operation.

### ◇ CP-18A/E fuse replacement

If the fuse blows or the receiver stops functioning while operating with the optional CP-18A/E, find the source of the problem if possible, and replace the damaged fuse with a new rated one (FGB 5 A) as shown below.

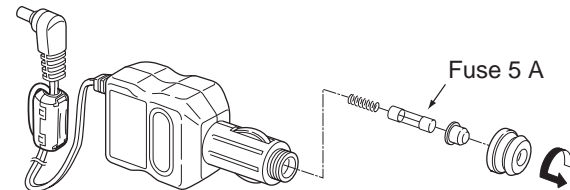

## ■ Power ON

- Push and hold [POWER] for 1 sec. to turn power ON.
  - Push and hold [POWER] for 1 sec. to turn power OFF.

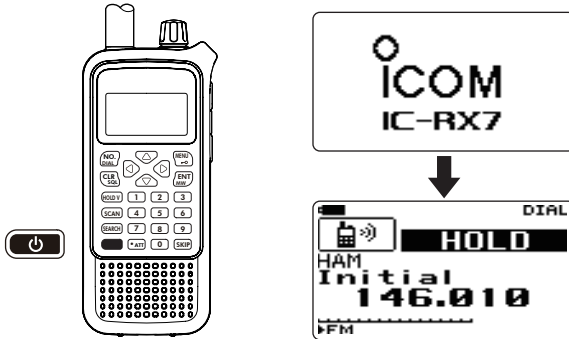

## ■ Setting audio volume

- Push [▲] or [▼] several time to adjust the audio level.
  - If squelch is closed, push and hold [CLR SQL] for 1 sec. to activate the monitor function ON while setting the audio level. Push [CLR SQL] again to return to normal operating mode.
  - The display shows the volume level while setting.

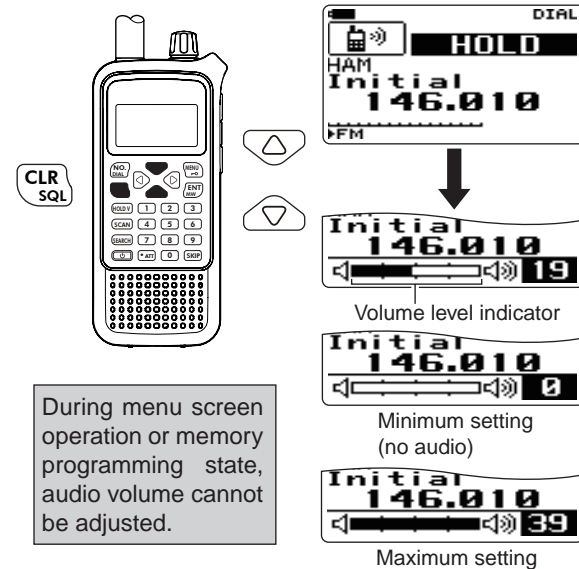

Beeper level is adjustable in SOUNDS menu.

MENU ⇨ SOUNDS ⇨ **BEEP LEVEL** (p. 70)

## ■ Setting squelch level

The squelch circuit mutes the received audio signal depending on the signal strength. The receiver has 9 squelch levels, a continuously open setting and an automatic squelch setting.

- ➔ After pushing and holding **[CLR SQL]** for 1 sec., rotate **[DIAL]** to select the squelch level.
  - “LEVEL 1” is loose squelch (for weak signals) and “LEVEL 9” is tight squelch (for strong signals).
  - “AUTO” indicates automatic level adjustment by a noise pulse counting system.
  - “OPEN” indicates continuously open setting.
  - Push **[CLR SQL]** to return to normal operating mode.

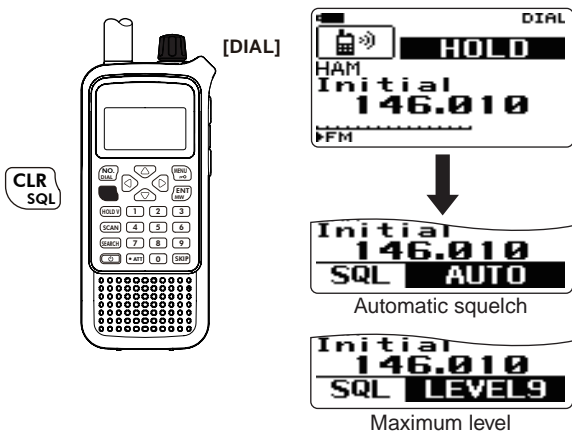

## ■ Monitor function

This function is used to listen to weak signals without disturbing the squelch setting or to open the squelch manually even when mute functions such as the tone squelch are in use.

- ➔ Push and hold **[CLR SQL]** for 1 sec. to monitor the operating frequency.
  - Push **[CLR SQL]** to clear the monitor function.

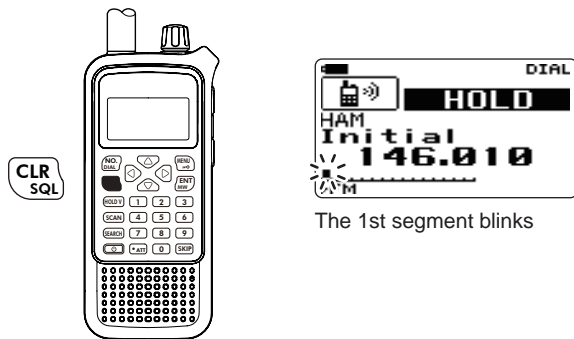

The 1st segment blinks

/// The squelch adjustment is available when the monitor function is active. See details on left.

## 4 BASIC OPERATION

### ■ Operating mode selection

#### ◇ VFO mode

VFO mode is used for the desired frequency setting within the frequency coverage.

- Push and hold **[HOLD V]** for 1 sec. to select VFO mode.
  - When VFO mode is selected, the previous displayed frequency, receiving mode, tuning steps, etc. are copied to VFO mode.



#### • VFO mode indication

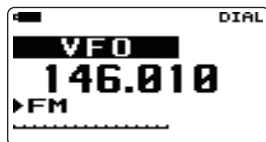

#### What is VFO?

VFO is an abbreviation of Variable Frequency Oscillator. Frequencies for receiving are generated and controlled by the VFO.

#### ◇ Operating band selection

The receiver can receive the AM broadcast, HF bands, 50 MHz, FM broadcast, VHF air, 144 MHz, 300 MHz, 400 MHz, 800 MHz\* or 1200 MHz bands.

- In VFO mode, push **[<|]** or **[>|]** several times to select the desired frequency band.
  - If VFO mode is not selected, such as a scan mode, or weather channel,<sup>†</sup> push and hold **[HOLD V]** to select VFO mode first, then push **[<|]** or **[>|]** to select the desired band. (<sup>†</sup> Available for USA and CANADA versions only.)
  - Search mode is also selectable operating bands.

Available frequency bands are different depending on version. See the specification for details. (p. 91)  
\* Some frequency ranges are blocked for the U.S.A. version by regulation.

Set the attenuator function ON (p. 75) if the received signal is blocked by other radio station when using a third party high-gain antenna.

• Available frequency bands

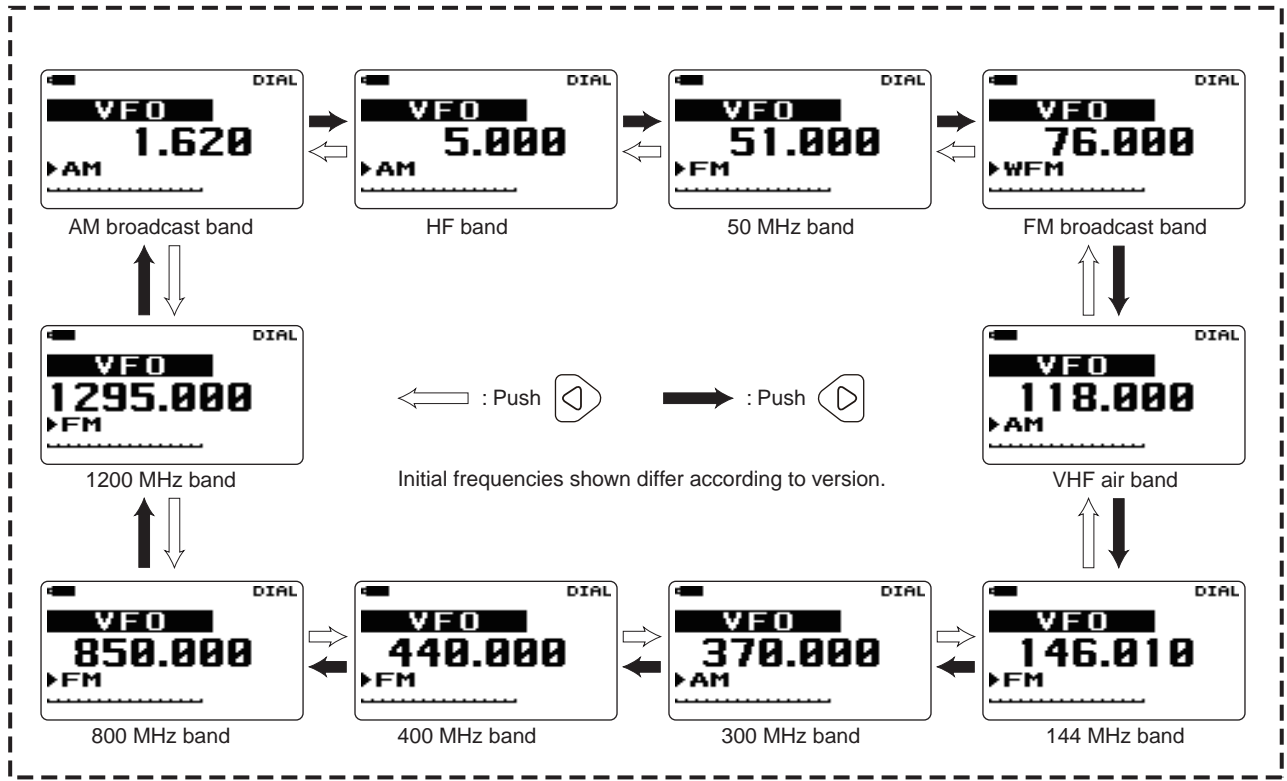

## 4 BASIC OPERATION

### ◇ Search mode

Search mode searches for signals for specified tuning steps automatically and makes it easier to locate new stations for listening purpose. Search mode is described in more detail in Section 6—SEARCH AND SCAN OPERATIONS.

- ① Push **[SEARCH]** to start a search.
  - Search pauses when a signal is received.
  - Rotate **[DIAL]** to change the searching direction.
- ② Push **[<|]** or **[>|]** several times to select the desired frequency band.
- ③ Push **[HOLD V]** to stop the search temporarily, if desired.
  - Rotate **[DIAL]** to change the frequency.
  - Push **[HOLD V]** again to restart the search.

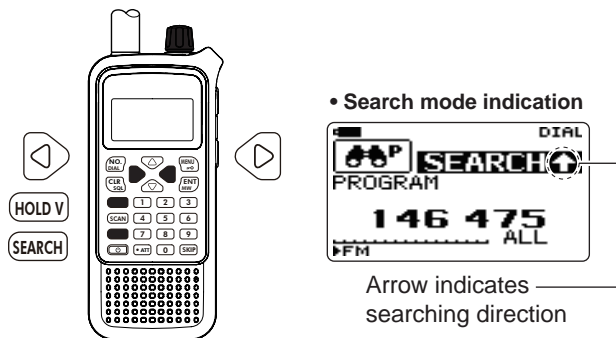

▨ **About the searching steps:** The selected tuning step in each frequency band (in VFO mode) is used during search.

### ◇ Scan mode

Scan mode searches for signals from the pre-programmed memory channels automatically. Scan mode is described in more detail in Section 6—SEARCH AND SCAN OPERATIONS.

- ① Push **[SCAN]** to start a scan.
  - Scan pauses when a signal is received.
  - Rotate **[DIAL]** to change the scanning direction.
- ② Push **[HOLD V]** to stop the scan temporarily, if desired.
  - Push and hold **[<|]** or **[>|]** for 1 sec. several times to select the desired category; or push **[<|]** or **[>|]** several times to select the desired group.
  - Rotate **[DIAL]** to select the channel.
  - Push **[HOLD V]** again to restart the scan.

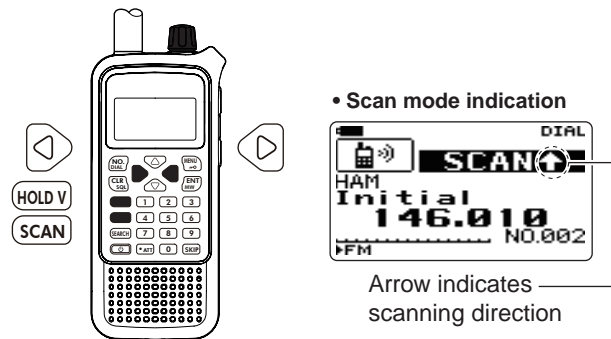

▨ During scan holding state, memory channels can be selected by the rotating **[DIAL]**.

## ■ Receiving mode selection

Receiving modes are determined by the modulation of the radio signals. The receiver has 3 operating modes: FM, WFM and AM modes. The mode selection is stored independently for each operating band and memory channels. (Auto mode is available for USA version only.)

Typically, AM mode is used for the AM broadcast stations (0.495–1.620 MHz) and air band (118–136.995 MHz), and WFM is used for FM broadcast stations (76–107.9 MHz).

- 1 Enter "MODE" in MODE/TS/TONE... menu.

MENU ⇨ MODE/TS/TONE ⇨ **MODE** (p. 63)  
(Push [MENU], (Push [Δ]/[▽], then push [ENT MW].)

- 2 Push [Δ]/[▽] (or rotate [DIAL]) to set the mode.
- 3 Push [ENT MW] (or [←]) to return to MODE/TS/TONE... menu, and push [CLR SQL] to return to frequency indication.

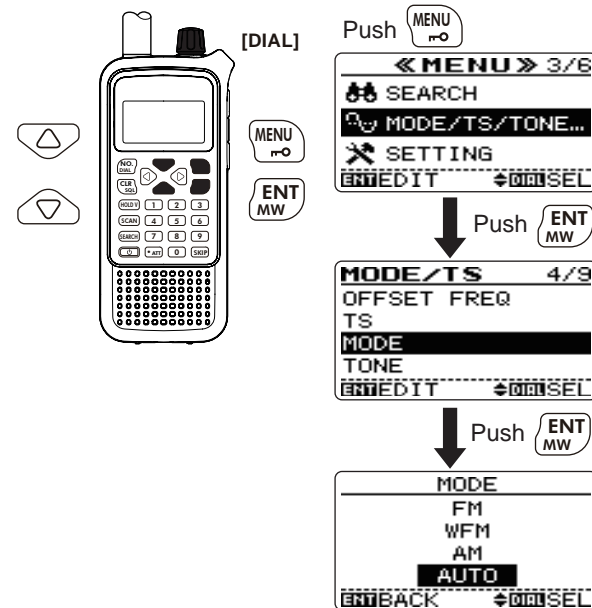

## ■ Setting a frequency

### ◇ Via the keypad (Direct frequency entry)

The frequency can be directly set via numeric keys.

- If a frequency outside the frequency range is entered, the previously displayed frequency is automatically recalled after editing last digit.

- ① Push and hold **[HOLD V]** to select VFO mode, if necessary.
- ② Enter the desired frequency via the keypad.

- Pushing **[ENT MW]** omits the entry of 100 kHz and below, when you want to edit to those digits "0."
- When a digit is mistakenly input, push **[CLR SQL]** to abort input.

Depending on the tuning step setting, it may not be possible to input a 1 kHz digit. In this case, enter "0" as 1 kHz digit, then rotate **[DIAL]** to set the desired frequency.

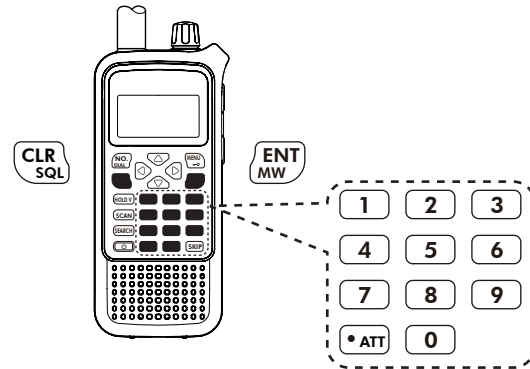



◇ Display example

- Entering 0.820 MHz

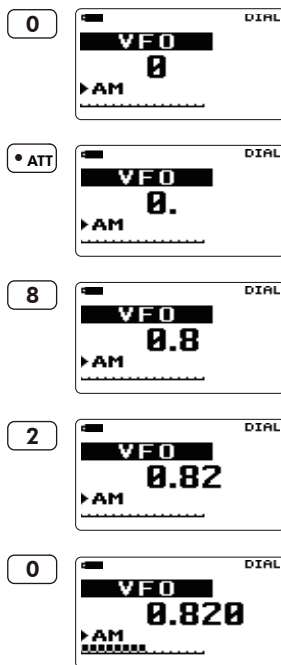

- Entering 1260 MHz

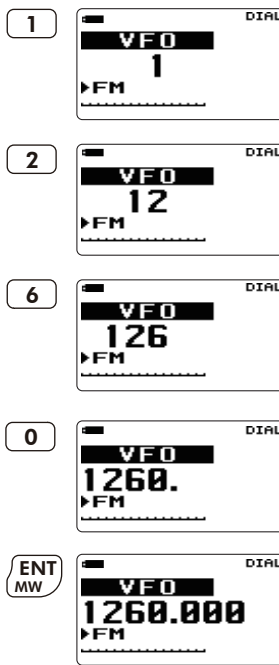

- Changing 100 kHz and below.

Editing  
1260.000 MHz  
to 1260.240 MHz

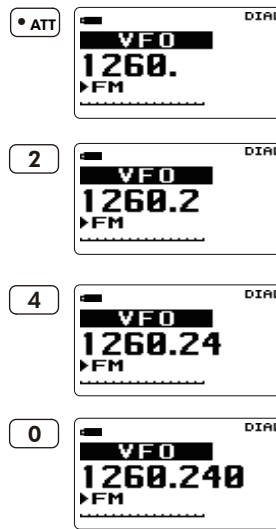

## 5 FREQUENCY SETTING

### ◇ Via the dial

- ① Push and hold [HOLD V] for 1 sec. to select VFO mode, if necessary.
- ② Push [<] or [>] to select the desired frequency band.
- ③ Rotate [DIAL] to select the desired frequency.
  - The frequency changes according to the preset tuning steps.  
See the next page for setting the tuning step.

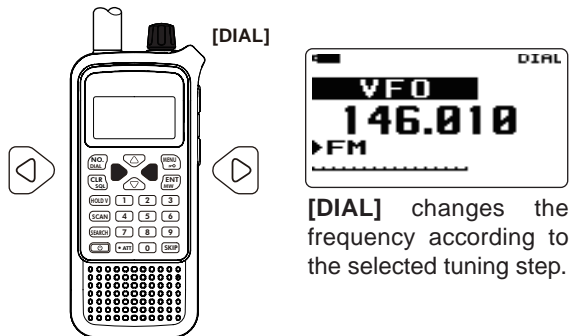

### ✓ CONVENIENT! (MHz tuning step mode)

Push and hold [<] or [>] for 1 sec. then rotate [DIAL] to change the frequency in 1 MHz steps, or push [<] again then rotate [DIAL] to change the frequency in 10 MHz steps. (After entering MHz tuning step mode, pushing [<] or [>] selects 10 MHz tuning steps or 1 MHz tuning steps, respectively.)

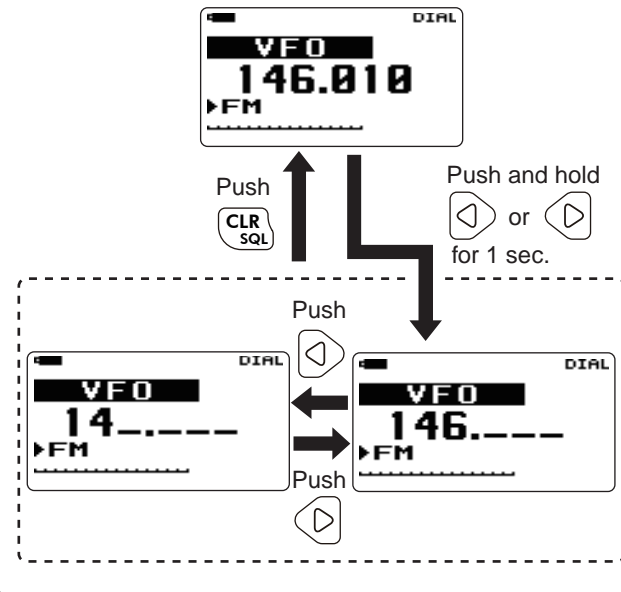

## ■ Setting a tuning step

The tuning step can be selected for each frequency band.  
The following tuning steps are available for the IC-RX7.

(Auto tuning step is available for USA version only.)

- 5.0 kHz • 6.25 kHz • 7.5 kHz • 8.33 kHz<sup>†</sup> • 9.0 kHz<sup>‡</sup>
- 10.0 kHz • 12.5 kHz • 15.0 kHz • 20.0 kHz • 25.0 kHz
- 30.0 kHz • 50.0 kHz • 100.0 kHz • 125.0 kHz • 200.0 kHz

<sup>†</sup> Appears for the VHF air band only.

<sup>‡</sup> Appears for the AM broadcast band only.

### ◇ Tuning step selection

- ① Push and hold [HOLD V] for 1 sec. to select VFO mode, if necessary.
- ② Push [◀] or [▶] to select the desired frequency band.
- ③ Enter "TS" in MODE/TS/TONE... menu.

MENU ⇨ MODE/TS/TONE ⇨ TS (p. 63)  
(Push [MENU ]), (Push [Δ]/[▽]), then push [ENT MW].)

- ④ Push [Δ]/[▽] (or rotate [DIAL]) to select the tuning step.
- ⑤ Push [ENT MW] (or [◀]) to return to MODE/TS/TONE... menu, and push [CLR SQL] to return to frequency indication.

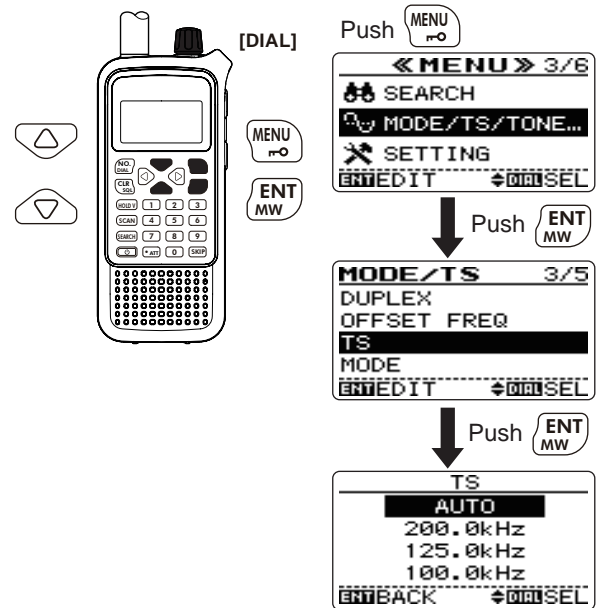

## Search and scan types

The IC-RX7's search and scan types are powerful tools for finding new stations, fast.

### FULL SEARCH (p. 26)

Repeatedly searches all frequencies over the entire band. Some frequency ranges are not searched according to the frequency coverage of the receiver's version.

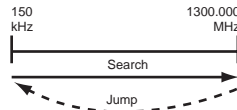

### PROGRAM SEARCH (p. 28)

Repeatedly searches between two user-programmed frequencies. Used for checking for frequencies within a specified range such as repeater output frequencies, etc.

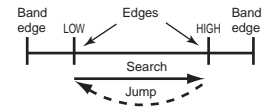

### BASIC SEARCH (p. 26)

Repeatedly searches all frequencies over the preprogrammed band by the optional cloning software CS-RX7. Air, Marine, Ham, Racing, Broadcast, and etc. are available (default setting).

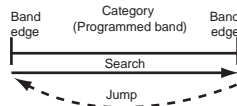

### PROGRAM LINK SEARCH (p. 29)

Repeatedly searches user-programmed frequencies selected at PROGRAM LINK item in the SEARCH menu. All program searches are linked in default settings.

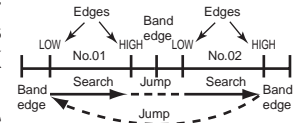

When the program search No.1 and No.2 are linked.

### BAND SEARCH (p. 27)

Repeatedly searches all frequencies over the entire selected band.

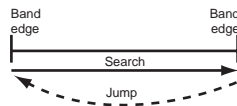

### AUTO WRITE SEARCH (p. 34)

The frequencies that the search pauses on are automatically stored into memory channels.

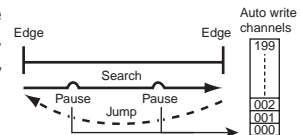

**NOTE:** Search or scan operation can be stopped temporarily by pushing **[HOLD V]**, but they cannot be cancelled.

**ALL SCAN** (p. 42)

Repeatedly scans all memory channels.

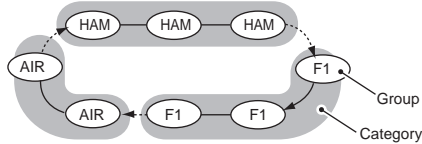

**GROUP SCAN** (p. 43)

Repeatedly scans all memory channels in the group.

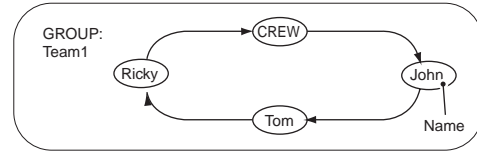

**CATEGORY SCAN** (p. 42)

Repeatedly scans all memory channels in the category.

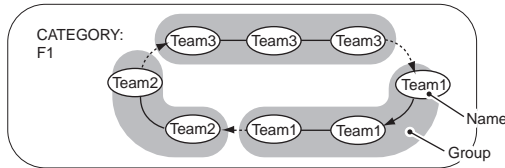

**LINK SCAN** (p. 41)

Repeatedly scans all memory channels in the category/group which selected in the category/group settings.

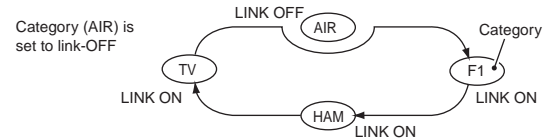

**FREQUENCY/MEMORY SKIP FUNCTION** (pgs. 36, 45, 46)

Skips unwanted frequencies or memory channels that inconveniently stop searching (or scanning). This can be turned ON/OFF by each memory channel/name/group/category.

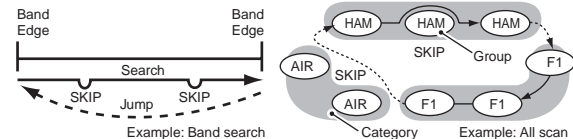

## 6 SEARCH AND SCAN OPERATIONS

### ■ Full search

- ① Push **[SEARCH]** to start the full search.
  - Search pauses when a signal is received.
  - Rotate **[DIAL]** to change the searching direction.
- ② Push **[◀]** or **[▶]** several times to select the desired frequency band.
- ③ Push **[HOLD V]** to stop the search temporarily, if desired.
  - Push **[HOLD V]** again to restart the search.

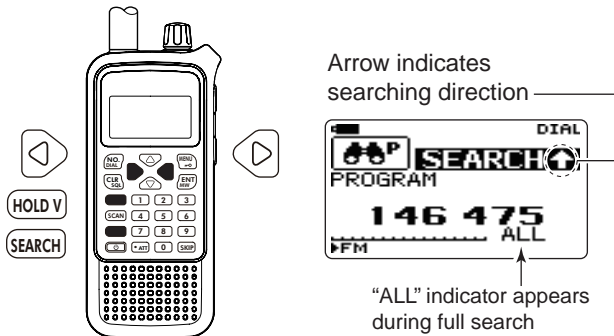

/// **About the searching steps:** The selected tuning step in each frequency band (in VFO mode) is used during search.

### ■ Basic search

- ① Enter "BASIC SEARCH" in SEARCH menu.

MENU ⇨ SEARCH ⇨ **BASIC SEARCH**  
(Push **[MENU]**, (Push **[△]**/**[▽]**, then push **[ENT MW]**.)

- SEARCH menu can also be entered by pushing and holding **[SEARCH]** for 1 sec.
  - 1st category appears.
- ② Push **[△]**/**[▽]** (or rotate **[DIAL]**) to select the desired category, then push **[ENT MW]** to start the search.
    - Search pauses when a signal is received.
    - Rotate **[DIAL]** to change the searching direction.
  - ③ Push **[HOLD V]** to stop the search temporarily, if desired.
    - Push **[HOLD V]** again to restart the search.

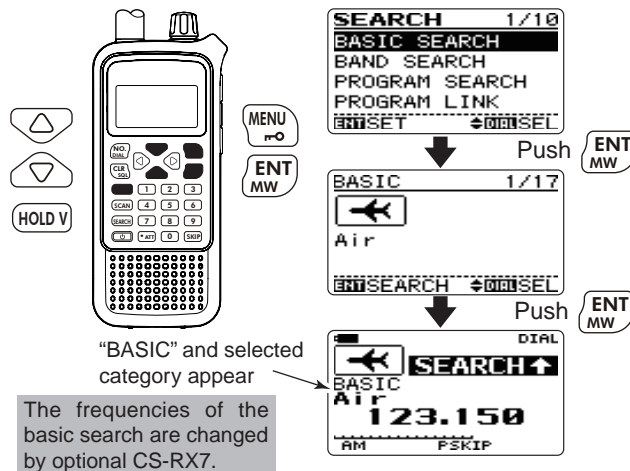

## ■ Band search

- ① Enter “BAND SEARCH” in SEARCH menu.

MENU ⇨ SEARCH ⇨ **BAND SEARCH**  
 (Push [MENU ) , (Push [△]/[▽], then push [ENT MW].)

- SEARCH menu can also be entered by pushing and holding [SEARCH] for 1 sec.
  - Band selection screen appears.
- ② Push [△] or [▽] several times (or rotate [DIAL]) to select the desired frequency band, then push [ENT MW] to start the search.
- Search pauses when a signal is received.
  - Rotate [DIAL] to change the searching direction.
  - After started the search, searching frequency band can be changed by pushing [◀] or [▶].
- ③ Push [HOLD V] to stop the search temporarily, if desired.
- Push [HOLD V] again to restart the search.

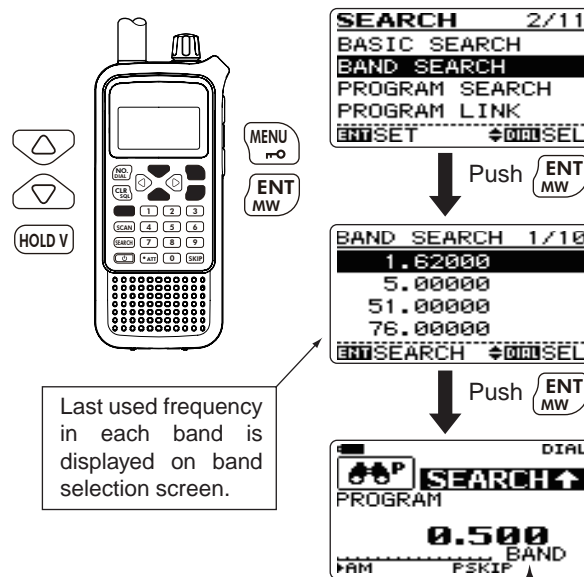

“BAND” indicator appears during band search

## 6 SEARCH AND SCAN OPERATIONS

### ■ Program search

- ① Enter "PROGRAM SEARCH" in SEARCH menu.

MENU → SEARCH → **PROGRAM SEARCH**  
(Push [MENU] ) (Push [△]/[▽], then push [ENT MW].)

- SEARCH menu can also be entered by pushing and holding [SEARCH] for 1 sec.
  - Program number selection screen appears.
- ② Push [△] or [▽] several times (or rotate [DIAL]) to select the desired program number, then push [ENT MW] to enter the program.
- A total of 25 program numbers (No. 00 to No. 24) are available.
- ③ Push [ENT MW] again to start the search.
- Search pauses when a signal is received.
  - Rotate [DIAL] to change the searching direction.
  - After started the search, program number can be changed by pushing [◀] or [▶].
- ④ Push [HOLD V] to stop the search temporarily, if desired.
- Push [HOLD V] again to restart the search.

**NOTE:** Program searches can be customized, see pages 30, 31 for programming details.

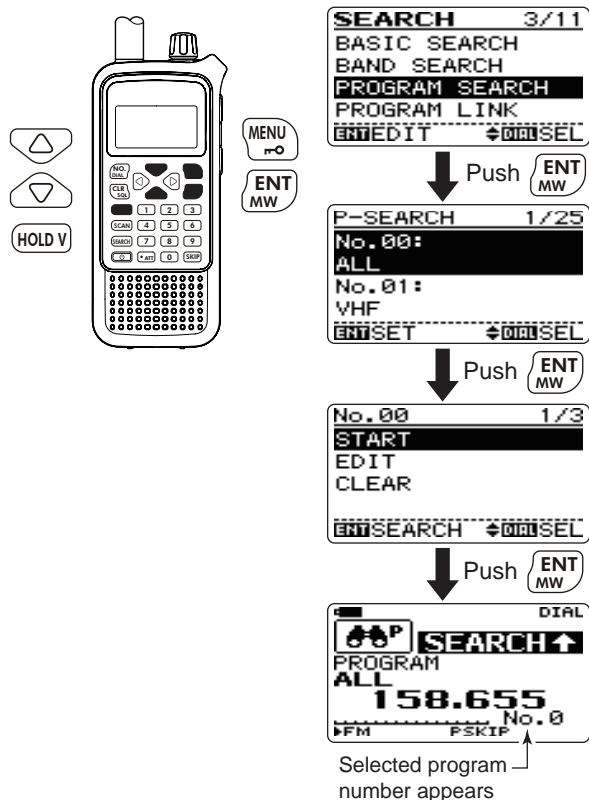



## ■ Program link search

- ① Enter "PROGRAM LINK SEARCH" in SEARCH menu.

MENU ⇨ SEARCH ⇨ **PROGRAM LINK SEARCH**  
(Push [MENU] (F), (Push [△]/[▽], then push [ENT MW].)

- SEARCH menu can also be entered by pushing and holding [SEARCH] for 1 sec.
  - Program link number selection screen appears.
- ② Push [△] or [▽] several times (or rotate [DIAL]) to select the desired program link number, then push [ENT MW] to enter the link edit state.
- A total of 10 program link numbers (No. 0 to No. 9) are available.
- ③ Push [ENT MW] again to start the search.
- Search pauses when a signal is received.
  - Rotate [DIAL] to change the searching direction.
  - After started the search, program link number can be changed by pushing [◀] or [▶].
- ④ Push [HOLD V] to stop the search temporarily, if desired.
- Push [HOLD V] again to restart the search.

**NOTE:** All program searches are linked in default settings. Program links can be customized, see pages 32, 33 for programming details.

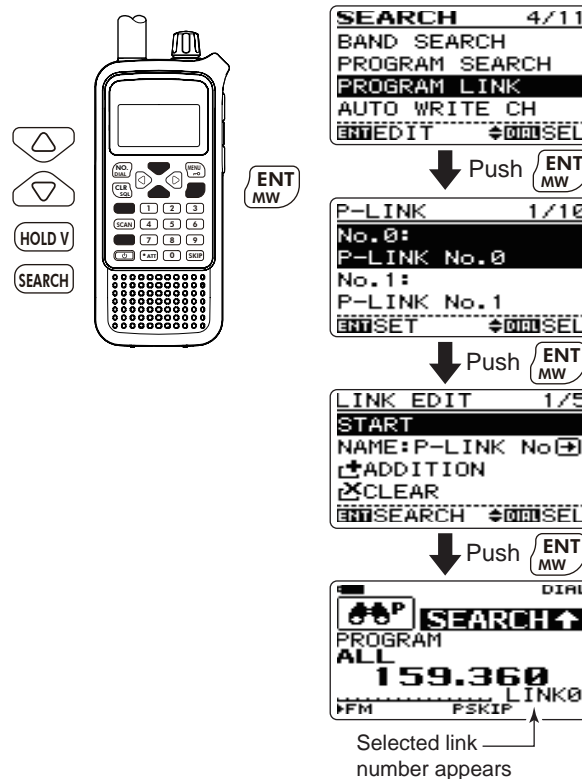

## 6 SEARCH AND SCAN OPERATIONS

### ■ Search edges programming

Search edges programming can be stored frequency edges, receiving mode, tuning steps, attenuator ON/OFF and search name. Any other items than the frequency edges are not necessary to program. In this case, settings of each frequency band are used to the search.

- ① Enter "PROGRAM SEARCH" in SEARCH menu.

MENU → SEARCH → **PROGRAM SEARCH**  
(Push [MENU] (F), (Push [Δ]/[∇], then push [ENT MW].))

- SEARCH menu can also be entered by pushing and holding [SEARCH] for 1 sec.
- Program number selection screen appears.

- ② Push [Δ] or [∇] several times (or rotate [DIAL]) to select the desired program number, then push [ENT MW] to enter the program.

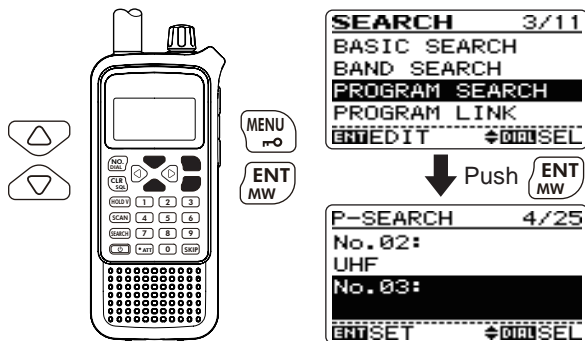

#### • EDIT

- ③ Push [∇] once (or rotate [DIAL]) to select "EDIT," then push [ENT MW] (or [▷]).

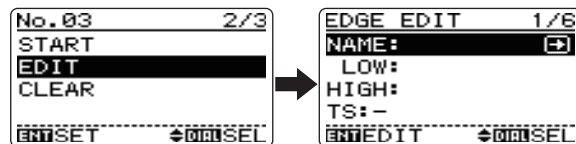

- ④ Set the desired edge frequencies either "LOW" or "HIGH."
- Push [∇] once or twice (or rotate [DIAL]) to select the item.
  - Other items cannot be programmed until these frequencies are input.

#### LOW/HIGH

- ① Push [ENT MW] (or [▷]) to enter the frequency input.

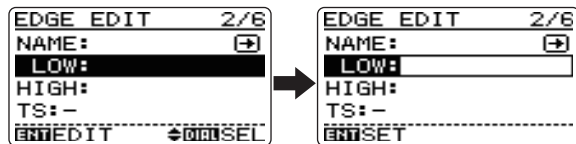

- ② Edit the desired frequency with keypad (pgs. 20, 21).

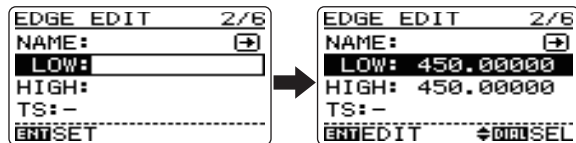

- ③ Push [Δ] or [∇] to select another edge, then edit different frequency.

⑤ Set the other items, if desired.

- Push [△] or [▽] several times (or rotate [DIAL]) to select the item, then push [ENT MW].

### NAME

- ① Push [ENT MW] (or [▷]) to edit the name programing.

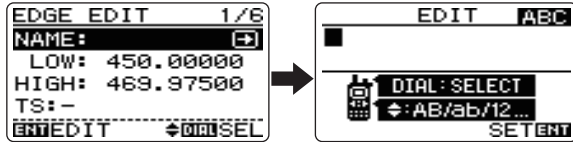

- ② Rotate [DIAL] to select the desired character.
- The selected character blinks.
  - Push [△] or [▽] to select the character group from “ABC” (alphabetical characters; capital letters), “abc” (alphabetical characters; lower case letters), “123” (numbers) or “!@#” (symbols). See next page for available characters details.
  - Push [◀] or [▶] to move the cursor left or right, respectively.
  - Push [CLR SQL] to clear the selected character.
  - Push and hold [CLR SQL] to repeat clearing continuously.
- ③ Push [ENT MW] to set the name and return to the program edge edit state.

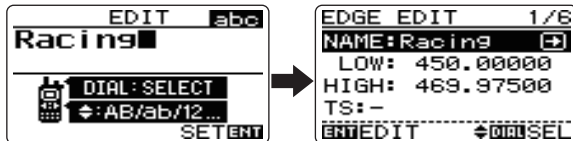

### TS/MODE/ATT

- ① Push [ENT MW] (or [▷]) to edit the tuning step setting.

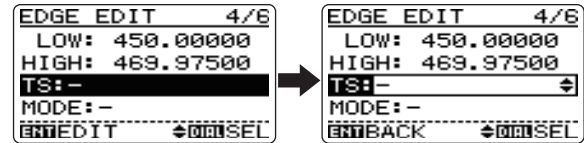

- ② Push and hold [△]/[▽] (or rotate [DIAL]) to select the desired setting.
- ③ Push [ENT MW] (or [▷]) to set the setting.
- ④ Set the mode or attenuator settings as same as steps ① to ③.

### • CLEAR

Continue from previous page's step ②.

- ③ Push [▽] twice (or rotate [DIAL]) to select “CLEAR,” then push [ENT MW] (or [▷]).
- “CLEAR?” window appears.
- ④ Push [△] (or rotate [DIAL]) to select “YES,” then push [ENT MW].
- Select “NO,” then push [ENT MW] to cancel clearing.
- ⑤ Push [◀] to finish the search edges clearing and return to the program number selection screen.

## 6 SEARCH AND SCAN OPERATIONS

### ■ Program link programming

Each program link can be programmed by linking program searches (No. 00 to No. 24), and can be programmed with an alphanumeric link name for easy recognition. 10 kinds of links are available.

- ① Enter "PROGRAM LINK" in SEARCH menu.

MENU ⇨ SEARCH ⇨ **PROGRAM LINK**  
(Push [MENU] (F-0)), (Push [Δ]/[∇], then push [ENT MW].)

- SEARCH menu can also be entered by pushing and holding [SEARCH] for 1 sec.
- Program link number selection screen appears.

- ② Push [Δ] or [∇] several times (or rotate [DIAL]) to select the desired program link number, then push [ENT MW] to enter the link edit state.

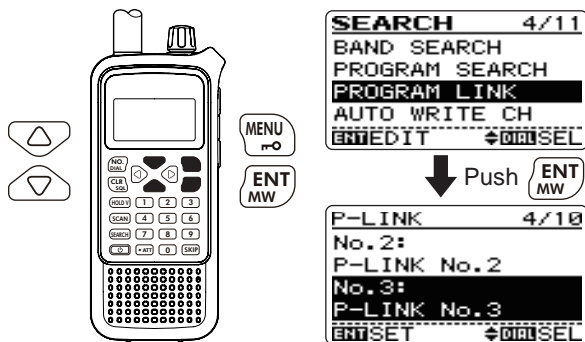

- ③ Push [∇] several time (or rotate [DIAL]) to select the following operations.

#### NAME

- 1 Push [ENT MW] (or [D>]) to edit the link name programming.
- 2 Rotate [DIAL] to select the desired character.
  - Selected character blinks.
  - Push [Δ] or [∇] to select the character group from "ABC" (alphabetical characters; capital letters), "abc" (alphabetical characters; lower case letters), "123" (numbers) or "!@#" (symbols).
  - Push [◀] or [▶] to move the cursor left or right, respectively.
  - Push [CLR SQL] to clear the selected character.
  - Push and hold [CLR SQL] to repeat clearing continuously.

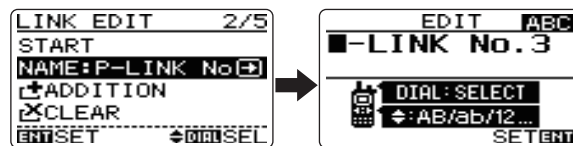

- ③ Push [ENT MW] to set the name and return to the link edit state.

#### • Available characters

ABCDEFGHIJKLMNOPQRSTUVWXYZ
abcdefghijklmnopqrstuvwxyz
0123456789
!"#\$%&'()*+,-./:;<=>?@[\\]^_`{ }~ (Space)

**CLEAR**

- 1 Push **[ENT MW]** (or **[▷]**) to edit the link clearing.
  - If all program searches are already cleared in the selected program link number, this item cannot be edited.

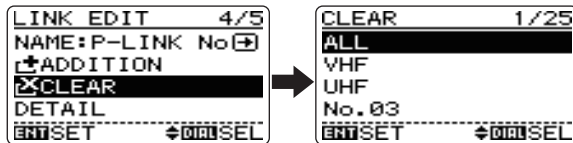

- 2 Push **[△]** or **[▽]** (or rotate **[DIAL]**) to select the program search to be unlinked.
- 3 Push **[ENT MW]** (or **[▷]**) to unlink the program search.
  - "CLEAR?" window appears.
- 4 Push **[△]** (or rotate **[DIAL]**) to select "YES," then push **[ENT MW]**.
  - Select "NO," then push **[ENT MW]** to cancel clearing.

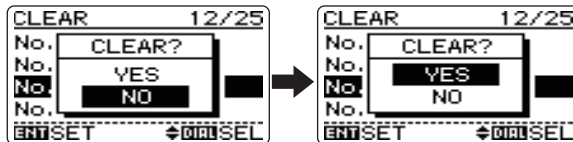

- 5 Push **[◀]** to finish the link clearing and return to the link edit state.

**ADDITION**

- 1 Push **[ENT MW]** (or **[▷]**) to edit the adding link.
  - If all program searches are already linked in the selected program link number, this item cannot be edited.

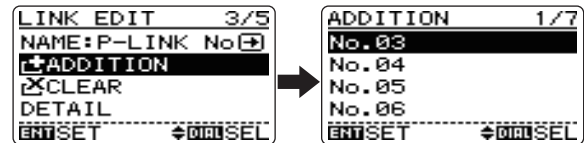

- 2 Push **[△]** or **[▽]** (or rotate **[DIAL]**) to select the desired program search.
- 3 Push **[ENT MW]** to set the link.
- 4 Push **[◀]** to finish the adding link and return to the link edit state.

**DETAIL**

- 1 Push **[ENT MW]** (or **[▷]**) to enter the program link details.
  - If no program searches are linked in the selected program link number, this item cannot be entered.

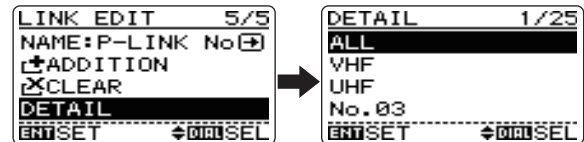

- 2 Push **[△]** or **[▽]** to select the program search.
- 3 Push **[ENT MW]** (or **[▷]**) to enter the program search.
- 4 Push **[◀]** to return to the link edit state.

## 6 SEARCH AND SCAN OPERATIONS

### ■ Auto write search

This search is useful for searching a specified frequency range and automatically storing busy frequencies into memory channels. The auto write search is performed with any search types. A total of 200 independent channels are available for storing auto write memory.

- ① Push **[SEARCH]** to start the full search.
  - Any other searches are also available (see pages 26 to 29).
  - Search pauses when a signal is received.
  - Rotate **[DIAL]** to change the searching direction.
- ② Push and hold **[ENT MW]** for 1 sec. to turn the auto write function ON and OFF.
  - "AW" indicator blinks.



#### • During auto write search

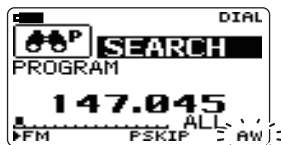

"AW" indicator blinks during auto write search.

- ③ Push **[HOLD V]** to stop the auto write search.

#### ◇ During auto write searching:

- When a signal is received, search pauses and the frequency is stored into auto write channel group (CH000 – CH199).
  - 2 short beeps sound when stored.
- Search resumes after frequency storing.
- When all channels are stored, the search is cancelled automatically and 1 long beep sounds.

### ◇ Recalling the stored frequencies:

- Enter "AUTO WRITE CH" in SEARCH menu.

MENU → SEARCH → **AUTO WRITE CH**  
(Push [MENU], (Push [Δ]/[▽], then push [ENT MW].)

- SEARCH menu can also be entered by pushing and holding [SEARCH] for 1 sec.
- Auto write channel appears.

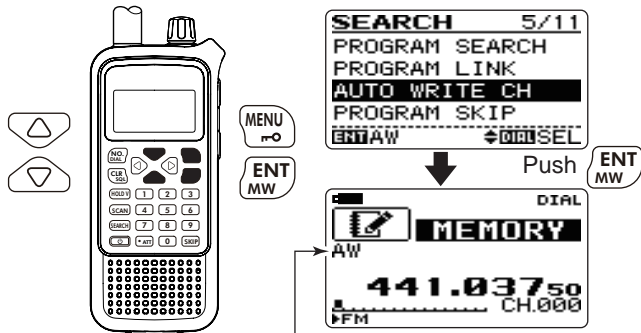

"AW" indicator appears

- Rotate [DIAL] to select the desired channel.

### ◇ Clearing the stored frequencies:

- Select the auto write channel group.
- Push and hold [SKIP] for 1 sec. to clear the all channel contents.
  - 1 short and 1 long beeps sound.

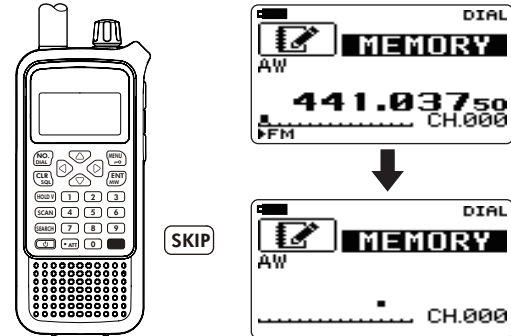

**NOTE:** The auto write channel contents CANNOT be cleared by an independent channel. Thus it is a good idea to copy the contents into regular memory channel.

## 6 SEARCH AND SCAN OPERATIONS

### ■ Skip search

During search operation, you can store the paused frequency into memory channel as a skip channel which is skipped during search. This setting is useful to speed up the search rate.

#### ◇ Setting

- ① Enter "PROGRAM SKIP" in SEARCH menu.

MENU → SEARCH → **PROGRAM SKIP**  
(Push [MENU] ) (Push [Δ]/[▽], then push [ENT MW].)

- SEARCH menu can also be entered by pushing and holding [SEARCH] for 1 sec.
- ② Push [Δ]/[▽] (or rotate [DIAL]) to select the program skip setting ON or OFF.
  - ③ Push [ENT MW] (or [←]) to return to SEARCH menu, and push [CLR SQL] to return to frequency indication.

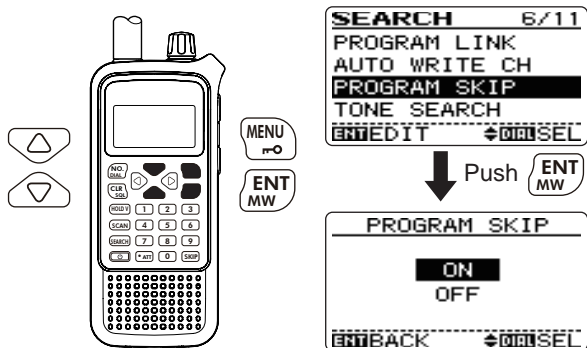

#### ◇ Operation

- ① Push [SEARCH] to start the full search.
  - Any other searches are also available (see pages 26 to 29).
  - "PSKIP" indicator blinks.
  - Search pauses when a signal is received.
  - Rotate [DIAL] to change the searching direction.
- ② When search pauses and you want to set the paused frequency as a skip frequency. Push and hold [SKIP] for 1 sec. to store the frequency into skip channel group in program search category.
  - Program search (category)/PSKIP1 (group) are made automatically when first skip channel is stored.
  - 1 long beep and 2 short beeps sound when stored.



#### • During Program skip search

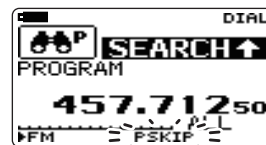

"PSKIP" indicator blinks during program skip search.

- ③ After that, stored frequencies are skipped during search.
  - This setting can be turned OFF by entering "PROGRAM SKIP" in SEARCH menu (see details on left).



## ■ Priority watch

### ◇ Priority watch types

Priority watch checks for signals on the memory channel(s) every 5 sec. while operating on VFO mode or searching. The receiver has 3 priority watch type to suit your needs.

The watch resumes according to the selected search resume condition. See page 40 for details.

**NOTE:** If the pocket beep function is activated, the receiver automatically selects the tone squelch or DTCS squelch function when priority watch starts.

#### • About priority beep function

When receiving a signal on the priority frequency, you can be alerted with beeps and a blink “(•)”. This function can be activated when setting the priority watch function ON.

#### MEMORY CHANNEL WATCH

While operating on a VFO frequency, priority watch checks for a signal on the selected memory channel every 5 sec.

- A memory channel with skip information can be watched.

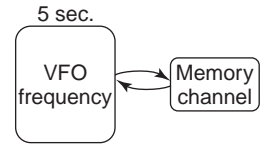

#### MEMORY CHANNEL WATCH DURING SEARCH

During search operation, priority watch checks for signals on the selected memory channel every 5 sec.

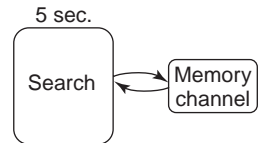

#### SCAN WATCH DURING SEARCH

During search operation, priority watch checks for signals on each memory channel in sequence.

- The memory skip function and/or category/group scan is useful to speed up the scan.

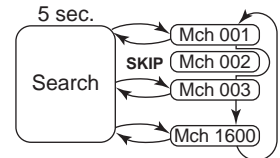

## 6 SEARCH AND SCAN OPERATIONS

### ◇ Memory channel watch

- ① Select the watching memory channel.
  - ➔ Push **[SCAN]** to start a scan, then push **[HOLD V]** to hold the scan.
  - ➔ Rotate **[DIAL]** to select the channel.
    - Push and hold **[<]** or **[>]** for 1 sec. to change the category, or push **[<]** or **[>]** to change the group.
- ② Select VFO mode and set the operating frequency, etc.
  - ➔ Push and hold **[HOLD V]** for 1 sec. to select VFO mode.
  - ➔ Set the operating frequency and receiving mode (pgs. 19–22).
- ③ Enter “PRIORITY” in SEARCH menu.

MENU ⇨ SEARCH ⇨ **PRIORITY**  
 (Push **[MENU F-O]**), (Push **[△]/[▽]**, then push **[ENT MW]**.)

- SEARCH menu can also be entered by pushing and holding **[SEARCH]** for 1 sec.



- ④ Push **[△]/[▽]** (or rotate **[DIAL]**) to select “ON.”
  - Select “BELL” if the priority beep function is desired.

- ⑤ Push **[CLR SQL]** to return to VFO mode and start the watch.
  - “PRIO” indicator appears.
  - The receiver checks the priority channel every 5 sec.
  - The watch resumes according to the selected search resume condition (p. 40), or push **[CLR SQL]** to resume manually.

#### • Memory channel watch



Monitors VFO frequency for 5 sec.



Pauses on a priority channel when a signal is received.

#### • Memory channel watch with priority beep



Emits beep and blinks “(•)” indicator when a signal is received on a priority channel.



- ⑥ Push **[CLR SQL]** to cancel the priority watch.

## ◇ Memory channel watch or scan watch during search

- ① Select the watching memory channel or scan.

### **For memory channel watch during search:**

- ➔ Push **[SCAN]** to start a scan, then push **[HOLD V]** to hold the scan.
- ➔ Rotate **[DIAL]** to select the channel.
  - Push and hold **[<]** or **[>]** for 1 sec. to change the category, or push **[<]** or **[>]** to change the group.

### **For scan watch during search:**

- ➔ Select the desired scan (pgs. 41–43).
  - Push and hold **[<]** or **[>]** for 1 sec. to change the category, or push **[<]** or **[>]** to change the group.

- ② Enter “PRIORITY” in SEARCH menu.

MENU ⇄ SEARCH ⇄ **PRIORITY**  
(Push **[MENU F-O]**), (Push **[Δ]/[▽]**), then push **[ENT MW]**.)

- SEARCH menu can also be entered by pushing and holding **[SEARCH]** for 1 sec.
- ③ Push **[Δ]/[▽]** (or rotate **[DIAL]**) to select “ON.”
- Select “BELL” if the priority beep function is desired.
- ④ Push **[ENT MW]** (or **[<]**) to return to SEARCH menu.
- ⑤ Push **[Δ]/[▽]** (or rotate **[DIAL]**) to select the desired search, then start the search.
- “PRIO” indicator appears.
  - The receiver checks the priority channel(s) every 5 sec.
  - The watch resumes according to the selected search resume condition (p. 40), or push **[CLR SQL]** to resume manually.

### • Priority watch during search



Searches frequencies for 5 sec.



Pauses on a priority channel when a signal is received.

### • Priority watch with priority beep during search



Emits beep and blinks “(•)” indicator when a signal is received on a priority channel without pausing on the channel.



- ⑥ Push **[CLR SQL]** to cancel the priority watch.

### ■ Other SEARCH menu items

#### ◇ Stop beep (STOP BEEP)

Selects the stop beep setting for search.

- OFF : The stop beep is turned OFF. (default)
- ON : The receiver emits a long beep when a search pauses with signal is received.

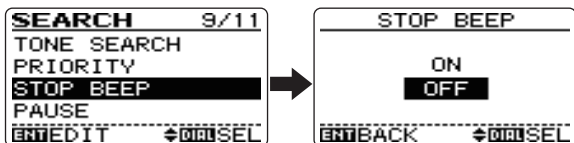

#### ◇ Search pause timer (PAUSE)

Selects the search pause time. When receiving signals, the search pauses according to the search pause time.

- 2–20 SEC : Search pauses for 2–20 sec. on a received signal in 2 sec. steps.
- HOLD : Search pauses on a received signal until it disappears. Rotate [DIAL] to resume manually. (default)



#### ◇ Search resume timer (RESUME)

Selects the search resume time from a pause after the received signal disappears.

- 0 SEC : Search resumes when a received signal disappears.
- 1–5 SEC : Search pauses 1–5 sec. after a received signal disappears. (default: 2 sec.)
- HOLD : Search remains paused on the received signal according to the search pause timer even if it disappears. Rotate [DIAL] to resume manually.



/// Search resume timer must be set shorter than search pause timer (previous item), otherwise this timer does not activate.

#### ◇ Tone search (TONE SEARCH)

This item appears only when FM mode is selected. See page 82 for tone search details.

## ■ Link scan

- ① Push **[SCAN]** to start a link scan.
  - Scan pauses when a signal is received.
  - Rotate **[DIAL]** to change the scanning direction.
- ② Push **[HOLD V]** to stop the scan temporarily, if desired.
  - Push and hold **[<]** or **[>]** for 1 sec. several times to select the desired category; or push **[<]** or **[>]** several times to select the desired group.
  - Rotate **[DIAL]** to select the channel.
  - Push **[HOLD V]** again to restart the scan.

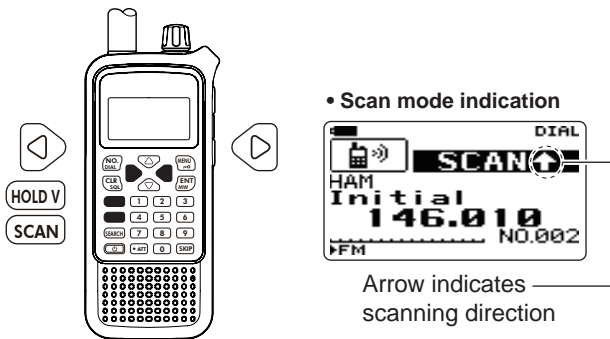

/// The category/group link setting can be changed in memory programming. See pages 52, 53 for details.

/// Scan skips any memory channels in the selected category/group/name that are set to “SKIP” or “PSKIP” (pgs. 52–54)

/// Link scan stops at the first channel when all channels in a category/group are set to “SKIP” or “PSKIP” (pgs. 52–54)

.....

/// **IMPORTANT!:** To perform scan functions, 2 or more memory channels **MUST** be programmed, otherwise the scans will not start.

## 6 SEARCH AND SCAN OPERATIONS

### ■ All scan

All scan repeatedly scans all memory channels programmed with any frequencies in the memory channel selected for scanning.

- 1 Enter "ALL SCAN" in SCAN menu.

MENU ⇨ SCAN ⇨ **ALL SCAN**  
(Push [MENU >]), (Push [Δ]/[▽]), then push [ENT MW].)

- SCAN menu can also be entered by pushing and holding [SCAN] for 1 sec.
  - Scan pauses when a signal is received.
  - Rotate [DIAL] to change the scanning direction.
- 2 Push [HOLD V] to stop the scan temporarily, if desired.
    - Push and hold [◀] or [▶] for 1 sec. several times to select the desired category; or push [◀] or [▶] several times to select the desired group.
    - Push [HOLD V] again to restart the scan.

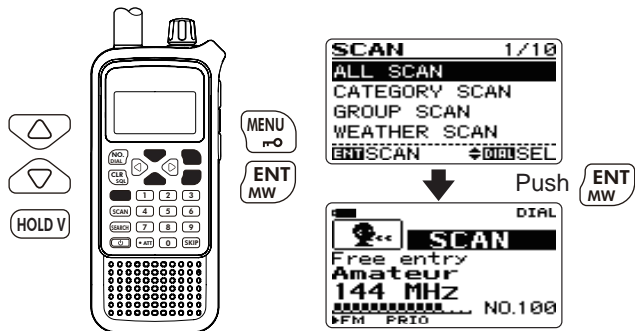

### ■ Category scan

Category scan repeatedly scans all memory channels in the same category as the selected memory channel has been programmed.

- 1 Enter "CATEGORY SCAN" in SCAN menu.

MENU ⇨ SCAN ⇨ **CATEGORY SCAN**  
(Push [MENU >]), (Push [Δ]/[▽]), then push [ENT MW].)

- SCAN menu can also be entered by pushing and holding [SCAN] for 1 sec.



- 2 Push [Δ]/[▽] (or rotate [DIAL]) to select the desired category, then push [ENT MW].
  - Scan pauses when a signal is received.
  - Rotate [DIAL] to change the scanning direction.



- 3 Push [HOLD V] to stop the scan temporarily, if desired.
  - Push and hold [◀] or [▶] for 1 sec. several times to select the desired memory category; or push [◀] or [▶] several times to select the desired group.
  - Push [HOLD V] again to restart the scan.

## ■ Group scan

Group scan repeatedly scans all memory channels in the same group as the selected memory channel has been programmed.

- ① Select the category that includes the desired group to be scanned.
  - ➔ Push **[SCAN]** to start a scan, then push **[HOLD V]** to hold the scan.
  - ➔ Push and hold **[<]** or **[>]** for 1 sec. to select the category.
- ② Enter "GROUP SCAN" in SCAN menu.
 

MENU → SCAN → **GROUP SCAN**  
 (Push **[MENU F-O]**), (Push **[Δ]/[▽]**), then push **[ENT MW]**.)

  - SCAN menu can also be entered by pushing and holding **[SCAN]** for 1 sec.
- ③ Push **[Δ]/[▽]** (or rotate **[DIAL]**) to select the desired group, then push **[ENT MW]**.
  - Scan pauses when a signal is received.
  - Rotate **[DIAL]** to change the scanning direction.
- ④ Push **[HOLD V]** to stop the scan temporarily, if desired.
  - Push and hold **[<]** or **[>]** for 1 sec. several times to select the desired memory category; or push **[<]** or **[>]** several times to select the desired group.
  - Push **[HOLD V]** again to restart the scan.

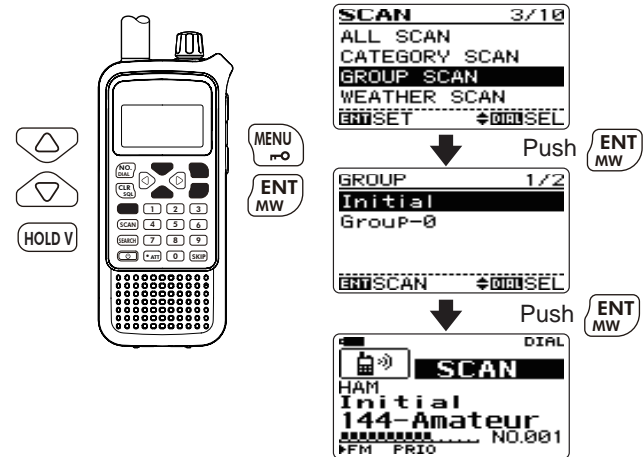

## 6 SEARCH AND SCAN OPERATIONS

### Weather channel operation

There are 10 weather channels for monitoring weather channels from the NOAA (National Oceanic and Atmospheric Administration) broadcasts.

#### Weather channel selection

- 1 Enter "WEATHER SCAN" in SCAN menu.

MENU → SCAN → **WEATHER SCAN**  
(Push [MENU] ) , (Push [Δ]/[▽] , then push [ENT MW].)

- SCAN menu can also be entered by pushing and holding [SCAN] for 1 sec.
  - "WX" and the weather channel number appear.
- 2 Push [HOLD V] to stop scanning.
  - 3 Rotate [DIAL] to select the desired weather channel.
  - 4 Push and hold [HOLD V] for 1 sec. to return to VFO mode.

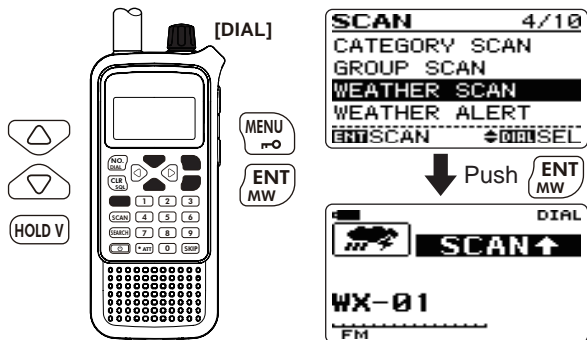

U.S.A. and CANADA versions only

#### Weather alert function

NOAA broadcast stations transmit weather alert tones before important weather announcements. When the weather alert function is turned ON, the selected weather channel is monitored every 5 sec. for the announcement. When the alert signal is detected, the "ALT" and the WX channel are displayed alternately and sounds a beep tone until the receiver is operated. The previously selected (used) weather channel is checked periodically during standby or while scanning.

- 1 Select the desired weather channel.
- 2 Enter "WEATHER ALERT" in SCAN menu.

MENU → SCAN → **WEATHER ALERT**  
(Push [MENU] ) , (Push [Δ]/[▽] , then push [ENT MW].)

- SCAN menu can also be entered by pushing and holding [SCAN] for 1 sec.
- 3 Push [Δ]/[▽] (or rotate [DIAL]) to select "ON" or "OFF."

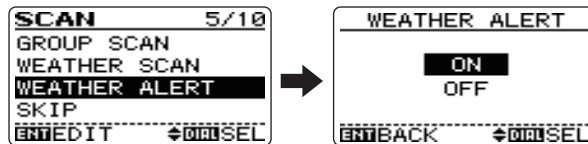

- 4 Push [ENT MW] (or [◀]) to return to SCAN menu, and push [CLR SQL] to return to the weather channel indication.



- ⑤ Set the desired stand-by condition.
  - Select VFO or memory channel.
  - Search, scan or priority watch operation can also be selected.
- ⑥ When the alert is detected, a beep sounds and the following indication will be displayed.

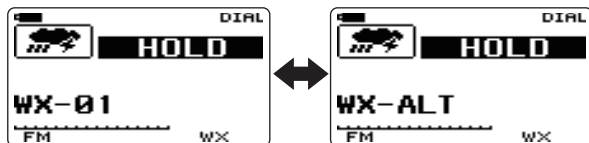

- ⑦ Turn the weather alert function OFF in SCAN menu.

**NOTE:** While receiving a signal (on a frequency other than the weather alert ON frequency), the receiving signal or audio will be interrupted momentarily every 5 sec. (approx.) in the case that the alert function is turned ON. This symptom is caused by the WX alert function. To cancel these symptoms, set the weather alert item OFF in SCAN menu.

## ■ Skip setting for scanning

Memory category/group/name can be set to be skipped during scan operation. In addition, memory channels can be set to be skipped during search or scan operation. This is useful to speed up the search or scan rate.

- ① Enter "SKIP" in SCAN menu.

MENU ⇨ SCAN ⇨ **SKIP**  
 (Push [MENU] , (Push [Δ]/[▽], then push [ENT MW].)

- SCAN menu can also be entered by pushing and holding [SCAN] for 1 sec.

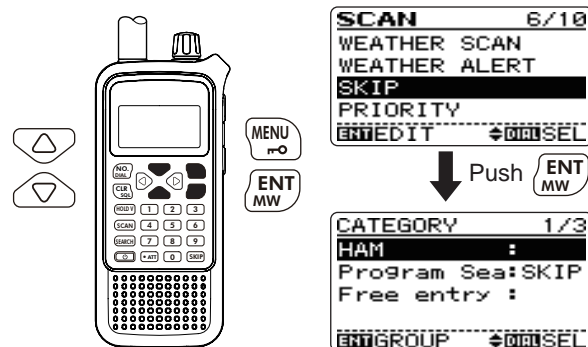

## 6 SEARCH AND SCAN OPERATIONS

- ② Push [**◀**]/[**▶**] once or twice to select “CATEGORY,” “GROUP” or “NAME.”

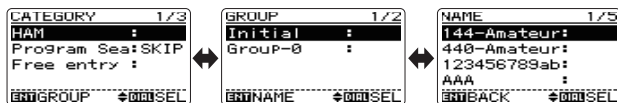

- ③ Push [**▲**]/[**▼**] (or rotate [**DIAL**]) to select the category (group/name) to be skipped.  
④ Push [**SKIP**] to set the skip state.  
• Push [**SKIP**] again to cancel the skip state.



- ⑤ Push [**ENT MW**] (or [**◀**]) several times to return to SCAN menu, and push [**CLR SQL**] to return to frequency indication.

---

### ✓ CONVENIENT! (Group skip setting)

The group skip setting can be set with the following operation during a scan or scan holding state.

- ① Select the desired memory group to be skipped.
  - ➔ Push [**SCAN**] to start a scan, then push [**HOLD V**] to hold the scan.
  - ➔ Push [**◀**] or [**▶**] to select the desired group.
    - Push and hold [**◀**] or [**▶**] for 1 sec. to change the category.
- ② Push and hold [**SKIP**] for 1 sec., and rotate [**DIAL**] to select the skip setting for the selected group from “ON (skip)” and “OFF,” then push [**ENT MW**].

---

### ✓ CONVENIENT! (Channel skip setting)

The channel skip setting can be set with the following operation during scan holding state.

- ① Select the desired memory channel to be skipped.
    - ➔ Push [**SCAN**] to start a scan, then push [**HOLD V**] to hold the scan.
    - ➔ Rotate [**DIAL**] to select the desired channel.
      - Push and hold [**◀**] or [**▶**] for 1 sec. to change the category, or push [**◀**] or [**▶**] to change the group.
  - ② Push [**SKIP**] several times to select the skip setting for the selected channel from “SKIP,” “PSKIP” and “OFF (no indication).”
-

## ■ Priority scan

During scan operation, priority scan checks for signals on the (preprogrammed) priority channels\* every 5 sec. Only this function is activate when the scan pauses other than priority channels for 5 sec. (\* See p. 55 for priority channel programming details.)

- Push **[SCAN]** to start the link scan.
  - Any other scans are also available (see pages 41 to 43).
  - Scan pauses when a signal is received.
  - Rotate **[DIAL]** to change the scanning direction.
- Enter "PRIORITY" in SCAN menu.
 

MENU → SCAN → **PRIORITY**  
 (Push **[MENU]**), (Push **[Δ]/[∇]**, then push **[ENT MW]**.)
- Push **[Δ]/[∇]** (or rotate **[DIAL]**) to select "ON."

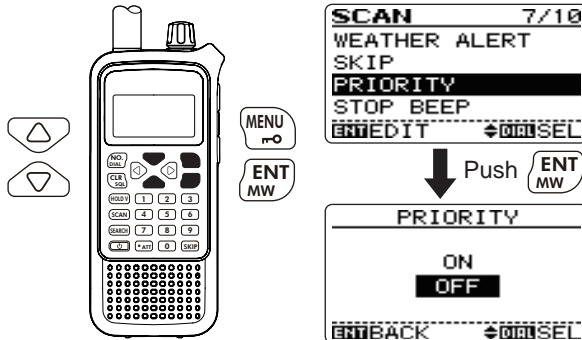

- Push **[ENT MW]** (or **[<|]**) to return to SCAN menu, and push **[CLR SQL]** to exit the menu screen operation and start the watch.
  - "PRIO" indicator appears.
  - The receiver checks the priority channel(s) after the scan pauses for 5 sec.
  - The watch resumes according to the selected scan resume condition (p. 48), or push **[CLR SQL]** to resume manually.



Pauses on a priority channel when a signal is received.

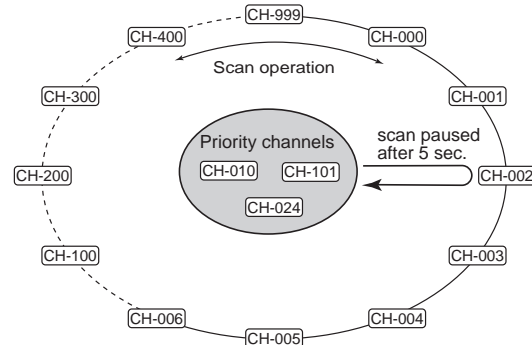

- Turn the priority watch function OFF in SCAN menu.

### Other SCAN menu items

#### ◆ Stop beep (STOP BEEP)

Selects the stop beep setting for scan.

- OFF : The stop beep is turned OFF. (default)
- ON : The receiver emits a long beep when a scan pauses with signal is received.

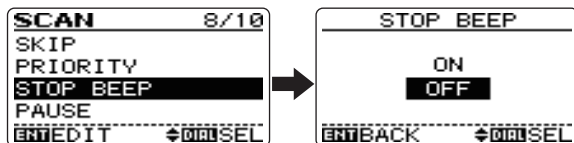

#### ◆ Scan pause timer (PAUSE)

Selects the scan pause time. When receiving signals, the scan pauses according to the scan pause time.

- 2–20 SEC : Scan pauses for 2–20 sec. on a received signal in 2 sec. steps.
- HOLD : Scan pauses on a received signal until it disappears. Rotate [DIAL] to resume manually. (default)

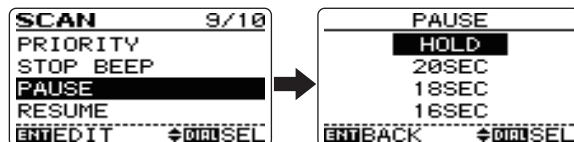

#### ◆ Scan resume timer (RESUME)

Selects the scan resume time from a pause after the received signal disappears.

- 0 SEC : Scan resumes when a received signal disappears.
- 1–5 SEC : Scan pauses 1–5 sec. after a received signal disappears. (default: 2 sec.)
- HOLD : Scan remains paused on the received signal according to the scan pause timer even if it disappears. Rotate [DIAL] to resume manually.

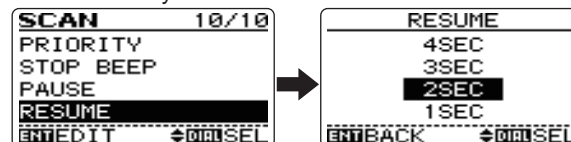

/// Scan resume timer must be set shorter than scan pause timer (previous item), otherwise this timer does not activate.

## ■ General description

A total of 1600 programming memory channels are available. The memory channels may be saved in up to 26 categories, and then sub-categorized even further!

The memory organization is follows:

- ① Category : Max. 26
- ② Group : Max. 100 (in each category)
- ③ Name : Max. 100 (in each group)
- ④ CH : Max. 6 (in each name)

## ◇ Memory channel contents

The following information can be programmed into memory channels:

- Operating frequency (pgs. 20, 21)
- Duplex direction (+DUP or -DUP) with an offset frequency (pgs. 76, 77)
- Tuning step (p. 23)
- Receiving mode (p. 19)
- Attenuator ON/OFF (p. 75)
- Skip setting (pgs. 36, 46)
- Priority setting (p. 47)
- Stop beep (p. 48)
- Tone squelch or DTCS squelch ON/OFF (p. 78)
- Tone squelch frequency or DTCS code with polarity (pgs. 80, 81)
- VSC setting (p. 85)

### CAUTION!

Memory data can be erased by static electricity, electric transients, etc. In addition, they can be erased by malfunction and during repairs. Therefore, we recommend that memory data be written down or be saved to a PC using the optional CS-RX7 CLONING SOFTWARE.

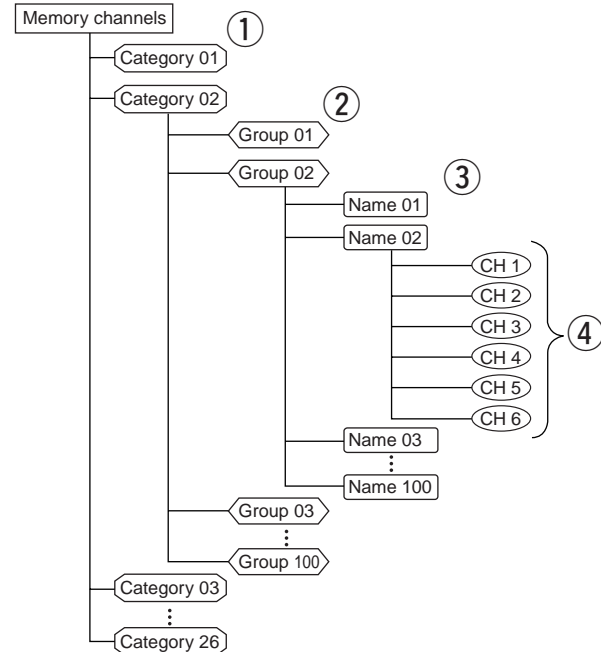

## Memory channel programming

- ① Push and hold **[HOLD V]** for 1 sec. to select VFO mode.
- ② Set the desired frequency, if desired:
  - Frequency or any other data can be set while in CH programming state.
  - ➔ Select the desired band with **[<|]** or **[>|]**.
  - ➔ Set the desired frequency with **[DIAL]**.
  - ➔ Or set the desired frequency with keypad directly.  
In this case, the band and frequency settings with **[<|/|>]** and **[DIAL]** as above are not required.
  - ➔ Set other data (e.g. offset frequency, duplex direction, tone squelch, etc.) in the menu screen.
- ③ Push and hold **[ENT MW]** for 1 sec. to enter the memory programming mode.
  - 1 short and 1 long beep sound.
  - Category selection screen appears.

### ✓ STORING SEARCHED FREQUENCY:

Another way to store information into memory channels is as follows:

- ① Start a search.
  - Search pauses when a signal is received.
  - Rotate **[DIAL]** to restart the search.
- ② Push **[HOLD V]** to hold the search, if you want to store the paused frequency into memory channel.
- ③ Push and hold **[ENT MW]** for 1 sec. to enter the memory programming mode.

- ④ Push **[△]** or **[▽]** (or rotate **[DIAL]**) to select the desired category or “ADDITION,” then push **[ENT MW]**.
  - When “ADDITION” is selected, new category can be programmed (see p. 52 for new category programming details).

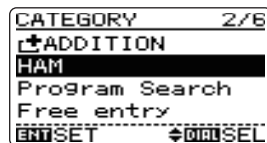

- ⑤ Push **[△]** or **[▽]** (or rotate **[DIAL]**) to select the desired group or “ADDITION,” then push **[ENT MW]**.
  - When “ADDITION” is selected, new group can be programmed in the category (see p. 53 for new group programming details).

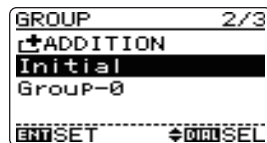

**NOTE:** The previous selected category or group are selected automatically when two or more memory channels are programmed continuously.

- ⑥ Push [ $\Delta$ ] or [ $\nabla$ ] (or rotate [DIAL]) to select the desired name or “ADDITION,” then push [ENT MW].
- When “ADDITION” is selected, new name can be programmed in the group (see p. 54 for new name programming details).



- ⑦ Push [ $\Delta$ ] (or rotate [DIAL]) to select “ADDITION,” then push [ENT MW].
- After “ADDITION” is selected, new channel can be programmed in the name (see p. 55 for new channel programming details).

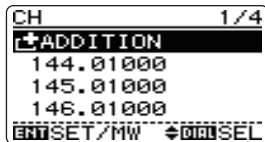

- ⑧ After all data are programmed, push and hold [ENT MW] for 1 sec. to store the channel and return to frequency display.

#### *What is DIRECT KEY?* (pgs. 52, 53)

The IC-RX7 has a total of 100 direct keys in the same category (0 to 99). Direct key is used to turn the link setting ON/OFF for the assigned category or group during link scan.

- 1 Push [SCAN] to start the link scan.
  - Scan pauses when a signal is received.
  - Rotate [DIAL] to restart the scan.
- 2 Push [HOLD V] to hold the scan.
  - Push a numeral key (0 to 9) to the link setting ON or OFF for the category or group which assigned a direct key (0 to 9).
  - Or push [ $\bullet$  ATT] and a numeral key (0 to 9), then push [ENT MW] to the link setting ON or OFF for the category or group which assigned a direct key (0 to 9).
  - Or push [ $\bullet$  ATT] and 2 digit number (00 to 99) to the link setting ON or OFF for the category or group which assigned a direct key (0 to 99).

## 7 MEMORY PROGRAMMING

### ◆ New CATEGORY programming

- Push [△] or [▽] (or rotate [DIAL]) to select the desired information.

Selectable information:

- NAME • ICON • SKIP • LINK • DIRECT KEY
- NEXT (Edit GROUP programming)

#### NAME (Category name)

- Push [ENT MW] (or [▷]) to edit the name programming.
- Rotate [DIAL] to select the desired character.
  - Push [△] or [▽] to select the character group from “ABC” (alphabetical characters; capital letters), “abc” (alphabetical characters; lower case letters), “123” (numbers) or “!@#” (symbols). See next page for available characters details.
  - Push [◀] or [▶] to move the cursor left or right, respectively.
  - Push [CLR SQL] to clear the selected character.
  - Push and hold [CLR SQL] to repeat clearing continuously.

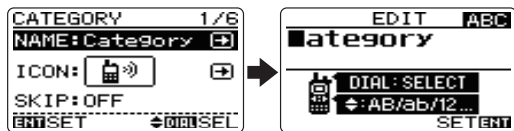

#### ICON

- Push [ENT MW] (or [▷]) to edit the setting state.
- Push [△] or [▽] (or [◀]/[▶]) (or rotate [DIAL]) to select the desired icon, then push [ENT MW].

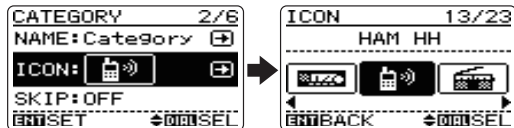

#### SKIP, LINK

- Push [ENT MW] (or [▷]) to edit the setting state.
- Push [△] or [▽] (or rotate [DIAL]) to select the desired setting, then push [ENT MW].

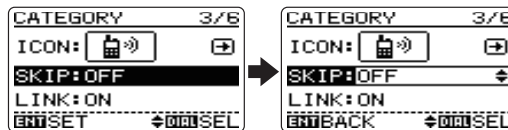

#### DIRECT KEY

- Push [ENT MW] (or [▷]) to enter the number input.
- Edit the desired 2 digit number with keypad.
  - Duplicated number can not be assigned in the same category (including direct key for group).
  - See p. 51 for direct key operation details.

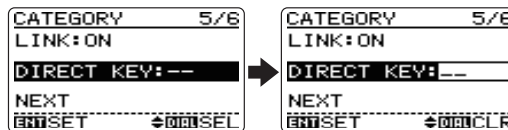

- Push [▽] (or rotate [DIAL]) to select “NEXT,” then push [ENT MW] to enter the GROUP programming state.



◇ **New GROUP programming**

① Push [△] or [▽] (or rotate [DIAL]) to select the desired information.

Selectable information:

- NAME                      • SKIP                      • LINK                      • DIRECT KEY
- NEXT (Edit NAME programming)

**NAME (Group name)**

① Push [ENT MW] (or [▷]) to edit the name programming.

② Rotate [DIAL] to select the desired character.

- Push [△] or [▽] to select the character group from “ABC” (alphabetical characters; capital letters), “abc” (alphabetical characters; lower case letters), “123” (numbers) or “!#” (symbols).
- Push [◀] or [▶] to move the cursor left or right, respectively.
- Push [CLR SQL] to clear the selected character.
- Push and hold [CLR SQL] to repeat clearing continuously.

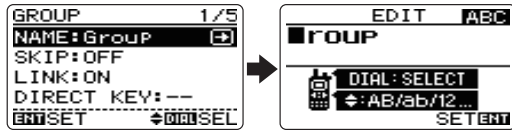

• **Available characters**

ABCDEFGHIJKLMNOPQRSTUVWXYZ
abcdefghijklmnopqrstuvwxyz
0123456789
!"#\$%&'()*+,-./:;<=>?@[\\]^_`{ }~ (Space)

**SKIP, LINK**

① Push [ENT MW] (or [▷]) to edit the setting state.

② Push [△] or [▽] to select the desired setting, then push [ENT MW].

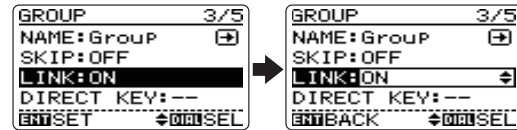

**DIRECT KEY**

① Push [ENT MW] (or [▷]) to enter the number input.

② Edit the desired 2 digit number with keypad.

- Duplicated number can not be assigned in the same category (including direct key for category).
- See p. 51 for direct key operation details.



② Push [▽] (or rotate [DIAL]) to select “NEXT,” then push [ENT MW] to enter the NAME programming state.

## 7 MEMORY PROGRAMMING

### ◇ New NAME programming

- ① Push [△] or [▽] (or rotate [DIAL]) to select the desired information.

Selectable information:

- NAME
- SKIP
- NUMBER
- NEXT (Edit CH programming)

#### NAME

- ① Push [ENT MW] (or [▷]) to edit the name programming.
- ② Rotate [DIAL] to select the desired character.
  - Push [△] or [▽] to select the character group from “ABC” (alphabetical characters; capital letters), “abc” (alphabetical characters; lower case letters), “123” (numbers) or “!@#” (symbols). See previous page for available characters details.
  - Push [◀] or [▶] to move the cursor left or right, respectively.
  - Push [CLR SQL] to clear the selected character.
  - Push and hold [CLR SQL] to repeat clearing continuously.

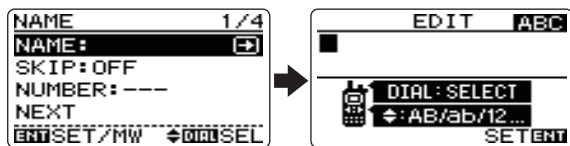

#### SKIP

- ① Push [ENT MW] (or [▷]) to edit the setting state.
- ② Push [△] or [▽] to select the desired setting, then push [ENT MW].

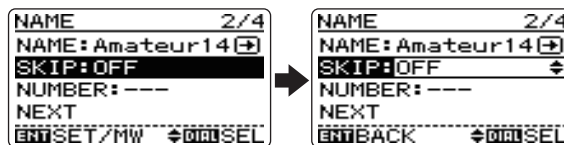

#### NUMBER

- ① Push [ENT MW] (or [▷]) to enter the number input.
- ② Edit the desired 1 to 3 digit number with keypad.
  - Duplicated number can not be assigned in the same category.
  - 0 to 9, 00 to 99, 000 to 999 can be assigned. Pushing [ENT MW] requires for 1 or 2 digit numbers input.

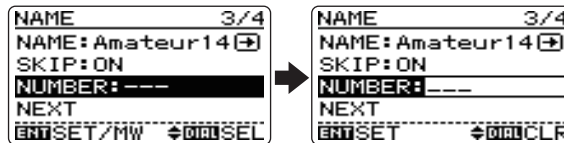

- ② Push [▽] (or rotate [DIAL]) to select “NEXT,” then push [ENT MW] to enter the CH programming state.
  - Or push and hold [ENT MW] for 1 sec. to program the memory channel and return to the frequency indication.
  - 1 short and 1 long beep sound.

◇ **New CH programming**

① Push [△] or [▽] (or rotate [DIAL]) to select the desired information.

**Selectable information:**

- FREQ           • DUP           • OFFSET       • TS
- MODE          • ATT          • SKIP         • PRIO
- STOP BEEP   • TONE        • TSQL FREQ   • DTCS CODE
- DTCS P       • VSC

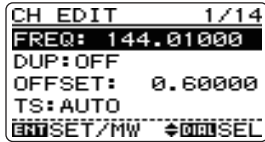

**FREQ, OFFSET**

- ① Push [ENT MW] (or [▷]) to enter the frequency input.
- ② Edit the desired frequency with keypad (pgs. 20, 21).

**Other information**

(DUP, TS, MODE, ATT, SKIP, PRIO, STOP BEEP, TONE, TSQL FREQ, DTCS CODE, DTCS P, VSC)

- ① Push [ENT MW] (or [▷]) to edit the setting state.
  - ② Push [△] or [▽] to select the desired setting, then push [ENT MW].
- ② Push and hold [ENT MW] for 1 sec. to program the channel and return to the frequency indication.
- 1 short and 1 long beep sound.

■ **Memory channel selection**

Memory channel can be selected during scan holding state.

- ① Push [SCAN] to start a scan, then push [HOLD V] to hold the scan.
- ② Push and hold [◀] or [▶] for 1 sec. to select the desired category.
- ③ Push [No. DIAL] and the assigned number to call the desired memory name in the category directly.
  - If the memory number is not assigned to the memory name, skip this step. (See p. 54 for number programming details.)

**When the assigned number is 0 to 9;**

➤ Push a number then push [ENT MW] to call the number.

**When the assigned number is 00 to 99;**

➤ Push 2 digit number then push [ENT MW] to call the number.

**When the assigned number is 000 to 999;**

➤ Push 3 digit number to call the number.

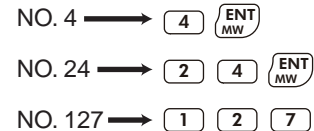
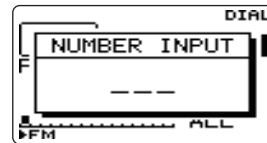

④ Rotate [DIAL] to select the channel.

## ■ Copying memory contents

This function copies a memory channel's contents to another memory channel. This is useful when searching for signals around a memory channel frequency and for recalling the offset frequency, subaudible tone frequency etc.

- ① Select the desired memory channel to be copied.
  - ➔ Push **[SCAN]** to start a scan, then push **[HOLD V]** to hold the scan.
  - ➔ Rotate **[DIAL]** to select the channel.
    - Push and hold **[<]** or **[>]** for 1 sec. to change the category, or push **[<]** or **[>]** to change the group.
- ② Push and hold **[ENT MW]** for 1 sec. to enter memory programming state.
  - 1 short and 1 long beep sound.



- ③ Push **[▽]** once (or rotate **[DIAL]**) to select "COPY," then push **[ENT MW]**.

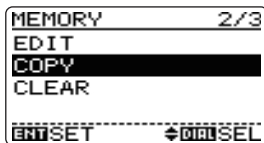

- ④ Push **[△]** or **[▽]** (or rotate **[DIAL]**) to select the desired category or "ADDITION," then push **[ENT MW]**.
  - When "ADDITION" is selected, new category can be programmed (see p. 52 for new category programming details).

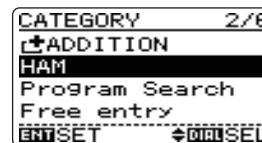

- ⑤ Push **[△]** or **[▽]** (or rotate **[DIAL]**) to select the desired group or "ADDITION," then push **[ENT MW]**.
  - When "ADDITION" is selected, new group can be programmed in the category (see p. 53 for new group programming details).

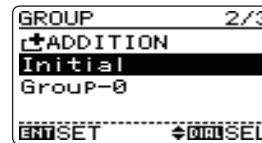

- ⑥ Push **[△]** or **[▽]** (or rotate **[DIAL]**) to select the desired name or “ADDITION,” then push **[ENT MW]**.
- When “ADDITION” is selected, new name can be programmed in the group (see p. 54 for new name programming details).



- ⑦ Push **[△]** or **[▽]** (or rotate **[DIAL]**) to select the target channel or “ADDITION,” then push **[ENT MW]**.
- When “ADDITION” is selected, new channel can be programmed in the name (see p. 55 for new channel programming details).

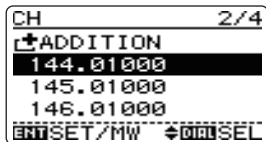

- ⑧ Push and hold **[ENT MW]** for 1 sec. to copy the channel and return to frequency display.

## ■ Changing memory contents

This function re-programs a memory category/group/name/channel's contents. This is useful when already programmed memory contents are changed or mistaken.

- ① Select the desired memory channel to be changed as previous page, then push and hold **[ENT MW]** for 1 sec. to enter memory programming state.
- 1 short and 1 long beep sound.

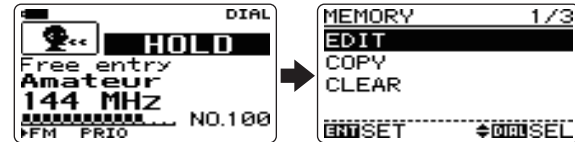

- ② Push **[ENT MW]** to enter the edit screen, and push **[▽]** several times (or rotate **[DIAL]**) to select “CATEGORY,” “GROUP,” “NAME” or “CH” to be changed, then push **[ENT MW]**.



- ③ Push **[△]** or **[▽]** (or rotate **[DIAL]**) to select the desired information and set the information (see pgs. 52–55 for programming details).
- ④ Push **[<]** to return the edit screen and select other items, or push **[CLR SQL]** to finish the programming.

## ■ Clearing memory contents

Contents of programmed memories can be cleared (erased), if desired.

- ① Select the desired memory channel to be erased as page 56, then push and hold [ENT MW] for 1 sec. to enter memory programming state.
  - 1 short and 1 long beep sound.



- ② Push [▽] twice (or rotate [DIAL]) to select "CLEAR," then push [ENT MW].
  - "CLEAR?" window appears.

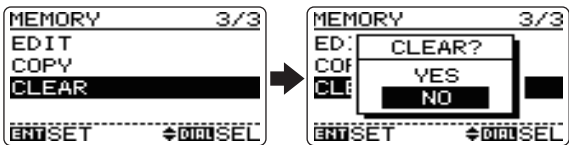

- ③ Push [△] to select "YES," then push [ENT MW] (or [▷]).
  - Select "NO," then push [ENT MW] to cancel clearing.
  - Returns to scan holding state.

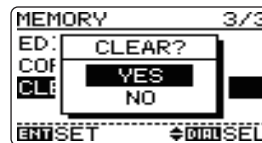

**BE CAREFUL!** — the contents of cleared memories CANNOT be recalled.

## ■ General

MENU screen is used for programming values or conditions of functions.

### ◇ Entering MENU screen and operation

e.g.) Set "AUTO power OFF" to 30 minutes.

- ① Push **[MENU **] to enter MENU screen.
- ② Push **[Δ]/[▽]** (or rotate **[DIAL]**) to select the desired menu group, then push **[ENT MW]**.

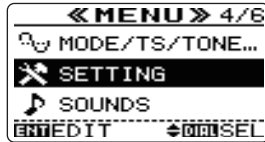

- ③ Push **[Δ]/[▽]** (or rotate **[DIAL]**) to select the desired item, then push **[ENT MW]** (or **[▷]**).

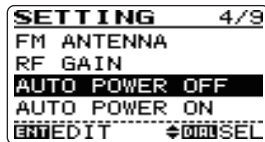

- ④ Push **[Δ]/[▽]** (or rotate **[DIAL]**) to select the desired value or condition, then push **[ENT MW]** (or **[▷]**) to return to the setting item selection mode.

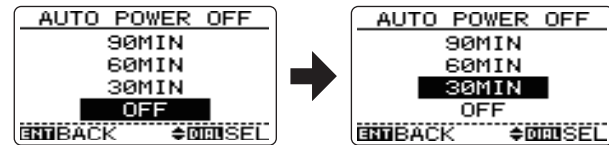

- ⑤ Push **[CLR SQL]** to return to frequency indication, or repeat steps ② to ④ to set another items.

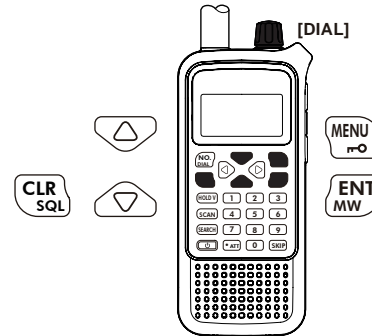

## 8 MENU SCREEN OPERATION

### ■ Menu lists

#### SCAN menu

ITEMS	REF.	SELECTIONS AND DESCRIPTION
ALL SCAN	p. 42	Push [ENT MW] to start
CATEGORY SCAN	p. 42	Select a category, then push [ENT MW] to start
GROUP SCAN	p. 43	Select a group, then push [ENT MW] to start
WEATHER SCAN	p. 44	Push [ENT MW] to start
WEATHER ALERT	p. 44	ON <b>OFF</b>
SKIP	p. 45	Skip setting ON/OFF for Category, Group or Name
PRIORITY	p. 47	ON <b>OFF</b>
STOP BEEP	p. 48	ON <b>OFF</b>
PAUSE	p. 48	<b>HOLD</b> 20SEC 18SEC 16SEC 14SEC 12SEC 10SEC 8SEC 6SEC 4SEC 2SEC
RESUME	p. 48	HOLD 5SEC 4SEC 3SEC <b>2SEC</b> 1SEC 0SEC

These lists show the default settings (highlighted) for USA version.

The default settings differ depending on versions.

#### SEARCH menu

ITEMS	REF.	SELECTIONS AND DESCRIPTION
BASIC SEARCH	p. 26	Select a category, then push [ENT MW] to start
BAND SEARCH	p. 27	Select a band, then push [ENT MW] to start
PROGRAM SEARCH	p. 28	Select a program, then push [ENT MW] twice to start
PROGRAM LINK	p. 29	Select a program-link, then push [ENT MW] twice to start
AUTO WRITE CH	p. 35	Push [ENT MW] to indicate the auto write channel
PROGRAM SKIP	p. 36	<b>ON</b> OFF
TONE SEARCH	p. 82	<b>TSQL</b> DTCS Appears only when FM mode is selected
PRIORITY	p. 38	BELL ON <b>OFF</b>
STOP BEEP	p. 40	ON <b>OFF</b>
PAUSE	p. 40	<b>HOLD</b> 20SEC 18SEC 16SEC 14SEC 12SEC 10SEC 8SEC 6SEC 4SEC 2SEC
RESUME	p. 40	HOLD 5SEC 4SEC 3SEC <b>2SEC</b> 1SEC 0SEC



### MODE/TS/TONE... menu

ITEMS	REF.	SELECTIONS AND DESCRIPTION
DUPLEX	p. 62	+DUP -DUP <b>OFF</b>
OFFSET FREQ	p. 62	<b>0.00000</b> Depending on the operating frequency
TS	p. 63	<b>AUTO</b> 200.0kHz 125.0kHz 100.0kHz 50.0kHz 30.0kHz 25.0kHz 20.0kHz 15.0 kHz 12.5 kHz 10.0kHz 9.0kHz <sup>†</sup> 8.33kHz <sup>†</sup> 7.5kHz 6.25kHz 5.0kHz <sup>†</sup> Available for some frequency band *AUTO* is available for USA version only
MODE	p. 63	FM WFM AM <b>AUTO</b> *AUTO* is available for USA version only Depending on the operating frequency
TONE*	p. 64	DTCS-R DTCS DTCS(⊕) TSQL-R TSQL TSQL(⊕) <b>OFF</b>
TSQL FREQ*	p. 64	<b>88.5</b> Push [Δ]/[▽] to set the tone frequency
DTCS CODE*	p. 65	<b>023</b> Push [Δ]/[▽] to set the DTCS code
DTCS POLARITY*	p. 65	<b>NORMAL</b> REVERSE
VSC	p. 65	ON <b>OFF</b>

\*Appears only when FM mode is selected

### SETTING menu

ITEMS	REF.	SELECTIONS AND DESCRIPTION
AM ANTENNA	p. 66	EXT-DX EXT-LOCAL <b>BAR</b>
FM ANTENNA	p. 66	<b>EXT</b> EARPHONE
RF GAIN	p. 67	<b>MAX</b> 9 8 7 6 5 4 3 2 1 MIN
AUTO POWER OFF	p. 67	120MIN 90MIN 60MIN 30MIN <b>OFF</b>
AUTO POWER ON	p. 67	<b>OFF</b> Push [Δ]/[▽] to set the timer in 30 min. steps
POWER SAVE	p. 67	<b>AUTO</b> OFF
DIAL SPEED-UP	p. 68	<b>ON</b> OFF
LOCK	p. 68	<b>NORMAL</b> NO SQL NO VOL ALL
CI-V	ADDRESS	p. 69 <b>78</b> Push [Δ]/[▽] to set the address
	BAUD RATE	p. 69 <b>AUTO</b> 19200bps 9600bps 4800bps 1200bps 300bps
	TRANSCEIVE	p. 69 <b>ON</b> OFF

### SOUNDS menu

ITEMS	REF.	SELECTIONS AND DESCRIPTION
KEY-TOUCH BEEP	p. 70	<b>ON</b> OFF
BEEP LEVEL	p. 70	<b>19</b> 0  39 Push [Δ]/[▽] to set the beep level
AF FILTER	p. 70	<b>ON</b> OFF When AM mode is selected
		ON <b>OFF</b> When WFM mode is selected
		----- Appears only when AM or WFM mode is selected
TONE CONTROL	BASS	p. 71 <b>BOOST</b> <b>NORMAL</b> CUT
	TREBLE	p. 71 <b>BOOST</b> <b>NORMAL</b> CUT

### DISPLAY menu

ITEMS	REF.	SELECTIONS AND DESCRIPTION
BACKLIGHT	p. 72	<b>AUTO</b> ON OFF
LCD CONTRAST	p. 72	<b>08</b> 1  15 Push [Δ]/[▽] to set the contrast
OPENING LOGO	p. 72	<b>ON</b> OFF
FONT SIZE	p. 72	SMALL <b>LARGE</b>

## MODE/TS/TONE menu items

### ◇ Duplex direction (DUPLEX)

Sets the duplex direction. The displayed frequency shifts the programmed frequency in offset frequency at right when monitor function is in use (After pushing and holding [CLR SQL] for 1 sec.).

- +DUP: The displaying frequency shifts up during monitor.
- -DUP: The displaying frequency shifts down during monitor.
- OFF : Simplex operation. (default)

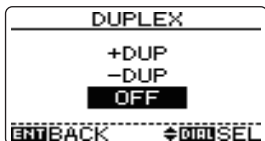

Simplex operation

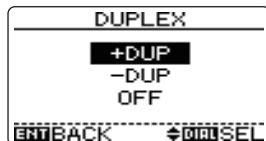

Positive duplex operation

### ◇ Offset frequency (OFFSET FREQ)

Sets the duplex offset frequency for each frequency band independently within 0 to 159.995 MHz range. During duplex operation (-DUP or +DUP), the monitoring frequency (after pushing and holding [CLR SQL] for 1 sec.) shifts the set frequency.

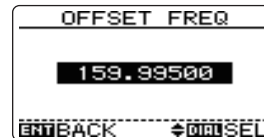

The default value may differ according to the selected frequency band (before accessing menu screen) and receiver version.

/// The selected tuning step at next column (right page) is used for the offset frequency setting.

◇ Tuning step (TS)

The tuning step can be selected for each frequency band, however, the tuning steps, 8.33 kHz and 9 kHz, appear when setting the tuning step for the VHF air band and AM broadcast band, respectively. The following tuning steps are available for the IC-RX7.

- 5.0 kHz • 6.25 kHz • 7.5 kHz • 8.33 kHz • 9.0 kHz
  - 10.0 kHz • 12.5 kHz • 15.0 kHz • 20.0 kHz • 25.0 kHz
  - 30.0 kHz • 50.0 kHz • 100.0 kHz • 125.0 kHz • 200.0 kHz
- AUTO tuning step is available for USA version only.

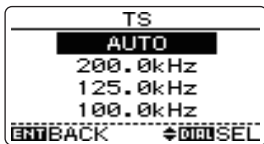

Auto tuning step

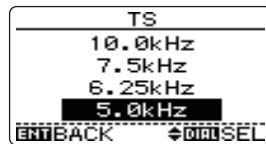

5 kHz tuning step

◇ Receiving mode (MODE)

Receiving modes are determined by the modulation of the radio signals. The receiver has 3 receiving modes: FM, WFM and AM modes. The mode selection is stored independently in each band and memory channels.

Typically, AM mode is used for the AM broadcast stations (0.495–1.620 MHz) and air band (118–136.995 MHz), and WFM is used for FM broadcast stations (76–107.9 MHz).

AUTO mode is available for USA version only.

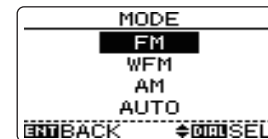
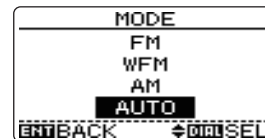

## 8 MENU SCREEN OPERATION

### ◇ Tone squelch/DTCS squelch setting (TONE)

Sets the tone squelch or DTCS squelch operation and pocket beep capability for when waiting for the desired signal. This setting appears only when FM mode is selected.

(default: OFF)

- DTCS-R : The squelch opens only when a signal with unmatched DTCS code is received.
- DTCS : Using DTCS squelch. The squelch opens only when a signal with matched DTCS code is received.
- DTCS(∘) : In addition to the “DTCS” setting, alert beeps will sound when a signal with matched DTCS code is received.
- TSQL-R : The squelch opens only when a signal with unmatched subaudible tone is received.
- TSQL : Using tone squelch. The squelch opens only when a signal with matched subaudible tone is received.
- TSQL(∘) : In addition to the “TSQL” setting, alert beeps will sound when a signal with matched tone is received.
- OFF : Regular noise squelch operation

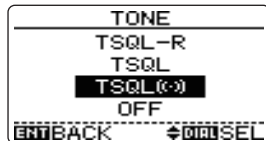
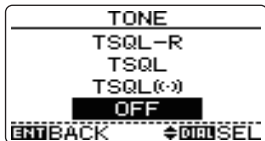

### ◇ Tone squelch frequency (TSQL FREQ)

Sets subaudible tone frequency for tone squelch operation. Total of 50 tone frequencies (67.0–254.1 Hz) are available. This setting appears only when FM mode is selected.

(default: 88.5 Hz)

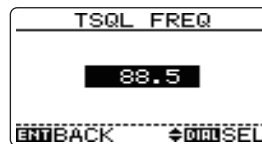

88.5 Hz setting

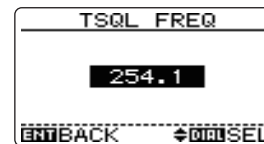

254.1 Hz setting

### • Available subaudible tone frequencies

67.0	79.7	94.8	110.9	131.8	156.7	171.3	186.2	203.5	229.1
69.3	82.5	97.4	114.8	136.5	159.8	173.8	189.9	206.5	233.6
71.9	85.4	100.0	118.8	141.3	162.2	177.3	192.8	210.7	241.8
74.4	88.5	103.5	123.0	146.2	165.5	179.9	196.6	218.1	250.3
77.0	91.5	107.2	127.3	151.4	167.9	183.5	199.5	225.7	254.1

◇ DTCS code (DTCS CODE)

Sets DTCS code for DTCS squelch operation. Total of 104 codes (023–754) are available. This setting appears only when FM mode is selected. (default: 023)



Code 023 setting

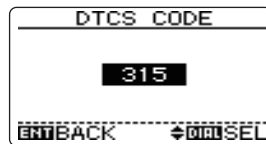

Code 315 setting

• Available DTCS code

023	054	125	165	245	274	356	445	506	627	732
025	065	131	172	246	306	364	446	516	631	734
026	071	132	174	251	311	365	452	523	632	743
031	072	134	205	252	315	371	454	526	654	754
032	073	143	212	255	325	411	455	532	662	
036	074	145	223	261	331	412	462	546	664	
043	114	152	225	263	332	413	464	565	703	
047	115	155	226	265	343	423	465	606	712	
051	116	156	243	266	346	431	466	612	723	
053	122	162	244	271	351	432	503	624	731	

/// The polarity can also be set in “DTCS polarity” at right.

◇ DTCS polarity (DTCS POLARITY)

Sets DTCS polarity from normal and reverse. This setting appears only when FM mode is selected.

(default: NORMAL)

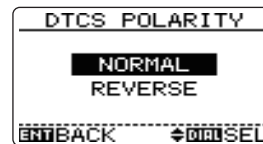

Normal setting

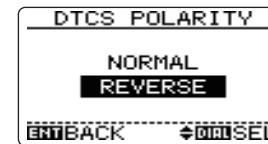

Reverse setting

◇ Voice squelch control (VSC)

This function is useful when you don't want unmodulated signals pausing or cancelling a search/scan. When the voice squelch control function is activated, the receiver checks received signals for voice components. If a received signal includes voice components, and the tone of the voice components changes within 1 sec., search/scan pauses (or stops). If the received signal includes no voice components or the tone of the voice components does not change within 1 sec., search/scan resumes. (default: OFF)

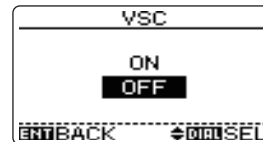

VSC is OFF

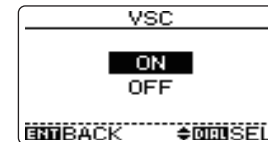

VSC is ON

## ■ SETTING menu items

### ◇ AM antenna selection (AM ANTENNA)

This setting is active only for the AM broadcast band, 0.495–1.620 MHz (differ according to the version) reception.

- **EXT-DX** : Use the antenna connected to the antenna connector, and then received signals are bypass the RF filter.
- **EXT-LOCAL** : Use the antenna connected to the antenna connector, and then received signals are filtered by the RF filter.
- **BAR** : Use the internal bar antenna for AM broadcast band reception. (default)



Bar antenna setting



External antenna (DX) setting

### ◇ FM antenna selection (FM ANTENNA)

This setting is active for all band and all receiving mode, but it is mostly effective only for the strong signal, such as FM broadcast band, 76.000–107.995 MHz (actual reception range differs according to version). When using an earphone, the FM antenna setting may cause interference on other bands, and should be turned OFF.

- **EXT** : Use the antenna connected to the antenna connector. (default)
- **EARPHONE** : Use the connected earphone's cable as the antenna for reception.



External antenna setting



Earphone antenna setting

/// The RF filter for EXT-LOCAL does not only reject the interference, but also reduces the receive sensitivity. Thus the EXT-LOCAL setting is not recommended for weak signal operation.

◇ RF gain level (RF GAIN)

The receiver gain can be reduced with the RF gain setting. This may help to remove undesired weak signals while monitoring strong signals.

The RF gain can be selected from 11 levels.

- MIN, 1 to 9 and MAX (default: MAX)

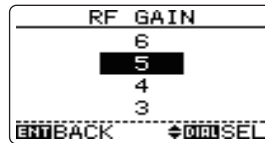
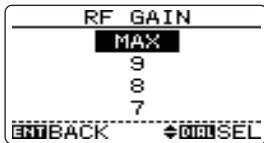

◇ Auto power OFF (AUTO POWER OFF)

Auto power OFF function turns the receiver power OFF after a specified time period when no key operations are performed. A warning beep indicates before the receiver powers OFF.

30 min., 60 min., 90 min., 120 min. and OFF (default) can be specified. The specified time period is retained even when the transceiver is turned OFF by the auto power OFF function. To cancel the function, select "OFF" in this item.



◇ Auto power ON (AUTO POWER ON)

Auto power ON function turns the receiver power ON automatically after passing the set time period from power OFF. Select the desired time period within 30 minutes to 24 hours in 30 minutes steps and OFF. (default: OFF)

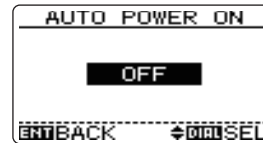

Timer is OFF

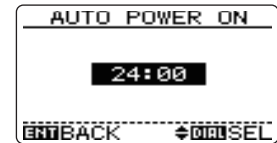

24 hrs. timer

◇ Power save (POWER SAVE)

The power save function reduces the current drain to conserve battery power. This power save function can be turned OFF, if desired.

- "AUTO" selects "1:4" duty ratio when receiving no signal for 5 sec., then "1:8" 60 sec. after that.

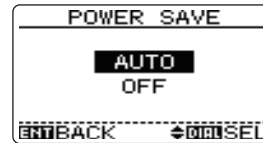

Power save is AUTO



Power save is OFF

**NOTE:** Power save function is inactivated when using the external power supply (More than 5.1 V DC).

## 8 MENU SCREEN OPERATION

### ◇ Dial acceleration (DIAL SPEED-UP)

The dial speed acceleration automatically speeds up the tuning dial speed when rotating **[DIAL]** rapidly.

- OFF : The dial speed acceleration is turned OFF.
- ON : The dial speed acceleration is tuned ON.  
(default)

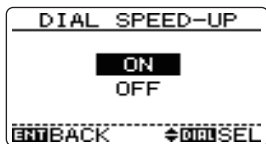

Dial acceleration is ON

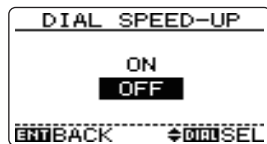

Dial acceleration is OFF

### ◇ Key lock type (LOCK)

While the key lock function is ON, **[POWER]**, **[CLR SQL]** (SQL function only), **[Δ]/[▽]** (volume function only) and **[MENU MSEL]** (Lock function only) can still be accessed. Accessible keys can be set to 1 of 4 groups.

- NORMAL : **[POWER]**, **[CLR SQL]** (SQL function only), **[Δ]/[▽]** (volume function only) and **[MENU MSEL]** (Lock function only) accessible. (default)
- NO SQL : **[POWER]**, **[CLR SQL]** (SQL function only) and **[MENU MSEL]** (Lock function only) are accessible.
- NO VOL : **[POWER]**, **[Δ]/[▽]** (volume function only) and **[MENU MSEL]** (Lock function only) are accessible.
- ALL : **[POWER]** and **[MENU MSEL]** (Lock function only) are accessible.

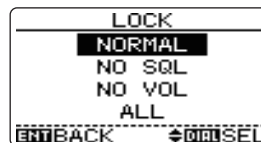

Normal lock condition

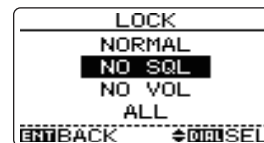

Squelch level can be adjusted

The function of tuning control, **[DIAL]**, and volume control, **[Δ]/[▽]**, can be traded. See page 77 for details.



◇ CI-V setting (CI-V SET)

This setting sets the CI-V address, CI-V baud rate and CI-V transceiver as follow.

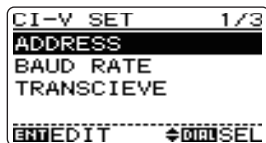

• CI-V address (ADDRESS)

To distinguish equipment, each CI-V transceiver/receiver has its own Icom standard address in hexadecimal number. The IC-RX7's address is "78."

When 2 or more IC-RX7s are connected to an optional CT-17 CI-V LEVEL CONVERTER, set a different address for each IC-RX7 in the range "01" to "7F." (default: 78)

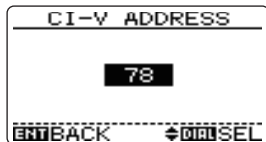

CI-V address set to 78

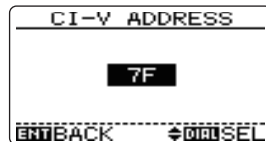

CI-V address set to 7F

• CI-V baud rate (BAUD RATE)

Sets the data transfer rate. When "AUTO" is selected, baud rate is automatically set according to the connected controller or other Icom CI-V radio. (default: AUTO)

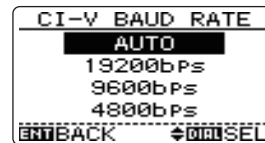

"AUTO" baud rate setting

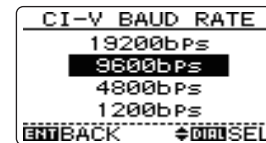

9600 bps setting

• CI-V transceiver (TRANSCEIVE)

CI-V transceiver operation is possible with the IC-RX7 connected to an Icom CI-V radio. When "ON" is selected, changing the frequency, operating mode on the IC-RX7 automatically changes those of connected radios and vice versa. (default: ON)

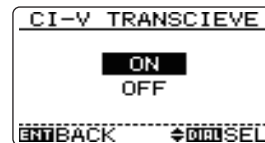

CI-V transceiver ON

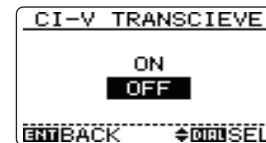

CI-V transceiver OFF

## ■ SOUNDS menu items

### ◇ Key-touch beep (KEY-TOUCH BEEP)

Turns the key-touch beep ON or OFF. (default: ON)



Key-touch beep ON

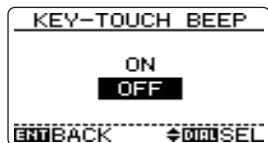

Key-touch beep OFF

### ◇ Beep output level (BEEP LEVEL)

Adjusts the key-touch beep tone level to the desired level within 40 levels (0 to 39).

The key-touch beep (previous item) must be set to ON to have a beep tone.

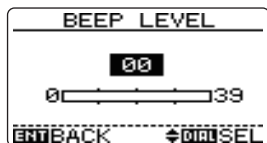

Minimum level (no audio)

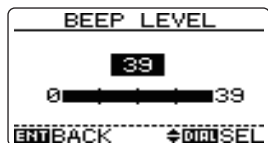

Maximum level

### ◇ AF filter (AF FILTER)

The AF filter suppresses high-pitch tone when this setting is ON. This function can be set for AM and WFM mode, but it does not appear for FM mode. Default setting for AM mode is "ON," and for WFM mode is "OFF."

- OFF : The AF filter is deactivate.
- ON : The AF filter is activate.



AF filter is OFF

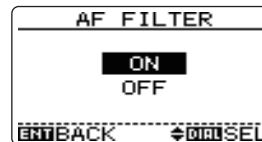

AF filter is ON

◇ **Tone control (TONE CONTROL)**

Sets the Bass and Treble level of the receive audio tone. This setting is mostly effective when a head phone, such as an optional HP-4 is used.

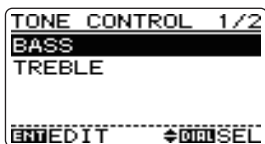

• **Bass level (BASS)**

Selects the bass level from CUT, NORMAL (default) and BOOST.



Normal setting

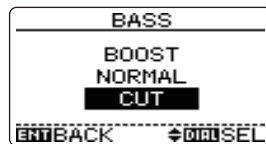

Bass tone is reduced

• **Treble level (TREBLE)**

Selects the bass level from CUT, NORMAL (default) and BOOST.

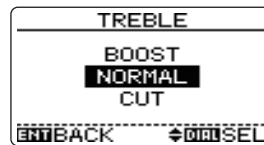

Normal setting

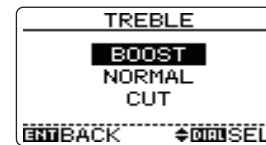

Treble tone is boosted

## ■ Display menu items

### ◇ Display backlighting (BACKLIGHT)

The receiver has display backlighting with a 5 sec. timer for night time operation. The display backlighting can be turned ON continuously or turned OFF, if desired.

- OFF : The backlight is turned OFF.
- ON : The backlight continuously lights ON.
- AUTO : Lights when an operation is performed, goes out after 5 sec. (default)



Auto setting



Continuously ON setting

### ◇ LCD contrast (LCD CONTRAST)

The contrast of the LCD can be selected from 15 levels.

- 1 (Low contrast) to 15 (High contrast) (default: 8)

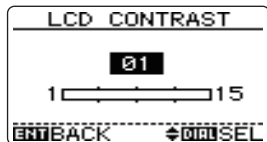

Low contrast

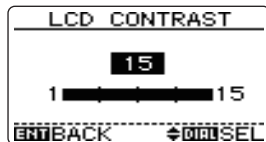

High contrast

### ◇ Opening logo (OPENING LOGO)

The opening logo indication (Icom logo and receiver name) that is displayed at power ON can be skipped, if desired.

- OFF : Opening logo indication is skipped.
- ON : Opening logo is displayed at power ON. (default)



Opening logo is ON



Opening logo is OFF

### ◇ Font size (FONT SIZE)

Displayed character size for group/name during scan operations or category during basic search operation is selectable from Large and Small.

- SMALL : Makes 16 characters on the line.
- LARGE : Makes 12 characters on the line (Scroll the characters if the longer than 13 characters). (default)



Large font size



Small font size

## ■ Antenna selection

The IC-RX7 has an internal bar antenna installed for receiving AM broadcast band (0.495–1.620 MHz; varies according to version) signals. In addition, the connected earphone's cable can be used as an antenna for receiving strong signals.

### ◇ Selecting antenna

- Enter “AM ANTENNA” or “FM ANTENNA” in SETTING menu for AM broadcast band or FM broadcast band, respectively.

MENU ⇨ SETTING ⇨ **AM ANTENNA** (p. 66)  
(Push [MENU], (Push [△]/[▽], then push [ENT MW].)

MENU ⇨ SETTING ⇨ **FM ANTENNA** (p. 66)

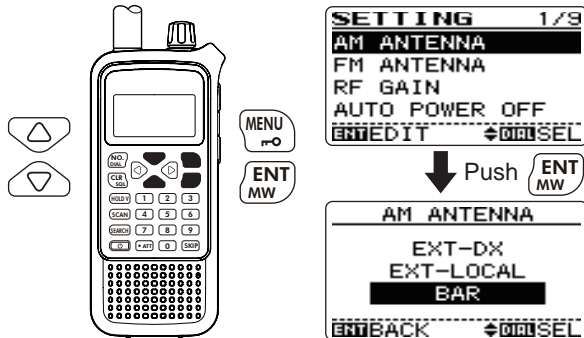

- Push [△]/[▽] (or rotate [DIAL]) to select “BAR” when “AM ANTENNA” is selected for the AM broadcast band; select “EARPHONE” when “FM ANTENNA” is selected for the strong signals.



Bar antenna selection for 0.495–1.620 MHz band



Earphone cable selection for strong signals

- Push [ENT MW] (or [←]) to return to SETTING menu, and push [CLR SQL] to return to frequency indication.

### NOTES:

- Some noise or spurious may be received when the internal bar or earphone cable is used as an antenna.
- The supplied or third party's antenna **MUST BE** connected to the antenna connector to receive signals other than AM or FM broadcast bands.
- When receiving an AM broadcast signal with internal bar antenna, aim the receiver to better audio direction.
- When the internal bar or earphone cable is used as an antenna, the attenuator function cannot be used.

## 9 OTHER FUNCTIONS

### ■ RF gain

The receiver gain can be reduced with the RF gain setting. This may help to remove undesired weak signals while monitoring strong signals.

- 1 Enter "RF GAIN" in SETTING menu.

MENU ⇨ SETTING ⇨ **RF GAIN** (p. 67)  
(Push [MENU ]), (Push [Δ]/[▽]), then push [ENT MW].)

- 2 Push [Δ]/[▽] (or rotate [DIAL]) to adjust the RF gain.
  - Normally this setting is used with maximum level.
- 3 Push [ENT MW] (or [<]) to return to SETTING menu, and push [CLR SQL] to return to frequency indication.
  - "RF" indicator appears when the RF gain is adjusted other than "MAX."

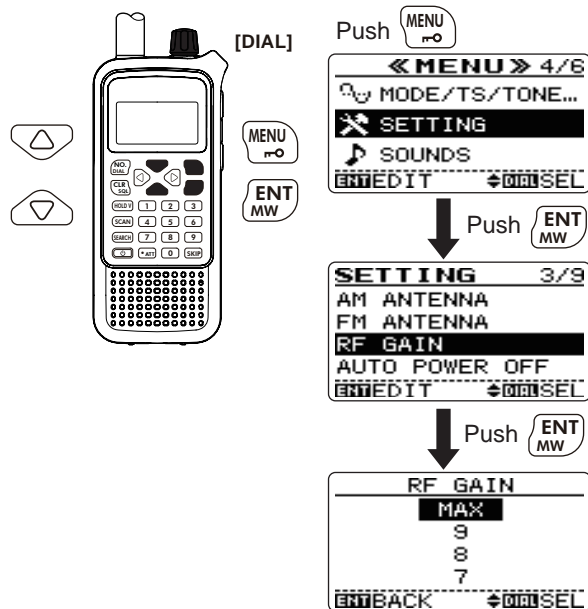
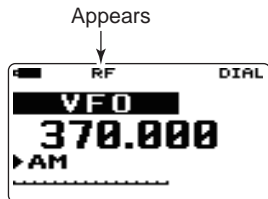

## ■ Attenuator function

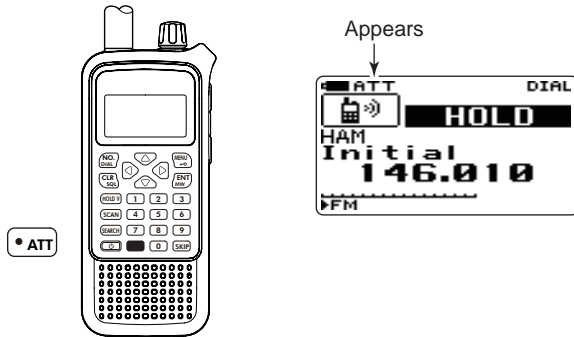

The attenuator prevents distortion of a desired signal by very strong signals near the desired frequency or when very strong electric fields, such as from a broadcasting station, are present at your location. The attenuation is about 15 dB depending on the operating frequency.

- ➔ Push and hold [**• ATT**] for 1 sec. to turn the attenuator function ON and OFF.
  - “ATT” appears on the function display.



## ■ Lock function

To prevent accidental frequency changes and unnecessary function access, use the lock function.

- ➔ Push and hold [**MENU** - “- The squelch control and volume control can be used while the lock function is activated with default setting. Either or both the squelch control and volume control can also be locked in setting menu.

MENU ⇨ SETTING ⇨ **LOCK** (p. 68)

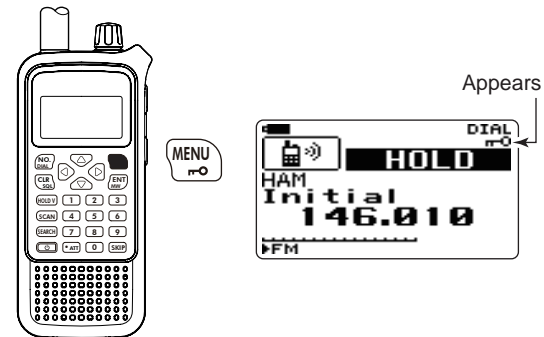

## ■ Duplex operation

Duplex communication uses 2 different frequencies for transmitting and receiving. Generally, duplex is used in conversational communications, when both parties can speak and hear at the same time.

During duplex operation, the transmit station frequency is shifted from the receive station frequency by the offset frequency. Repeater information (offset frequency and shift direction) can be programmed into memory channels. (p. 55)

### ◇ Setting

- ① Set the receive station frequency (repeater output frequency) in VFO mode.
- ② Enter "DUPLEX" in MODE/TS/TONE... menu.

MENU ⇨ MODE/TS/TONE... ⇨ **DUPLEX** (p. 62)  
 (Push [MENU ]), (Push [Δ]/[▽]), then push [ENT MW].)

- ③ Push [Δ]/[▽] (or rotate [DIAL]) to select "-DUP" or "+DUP."

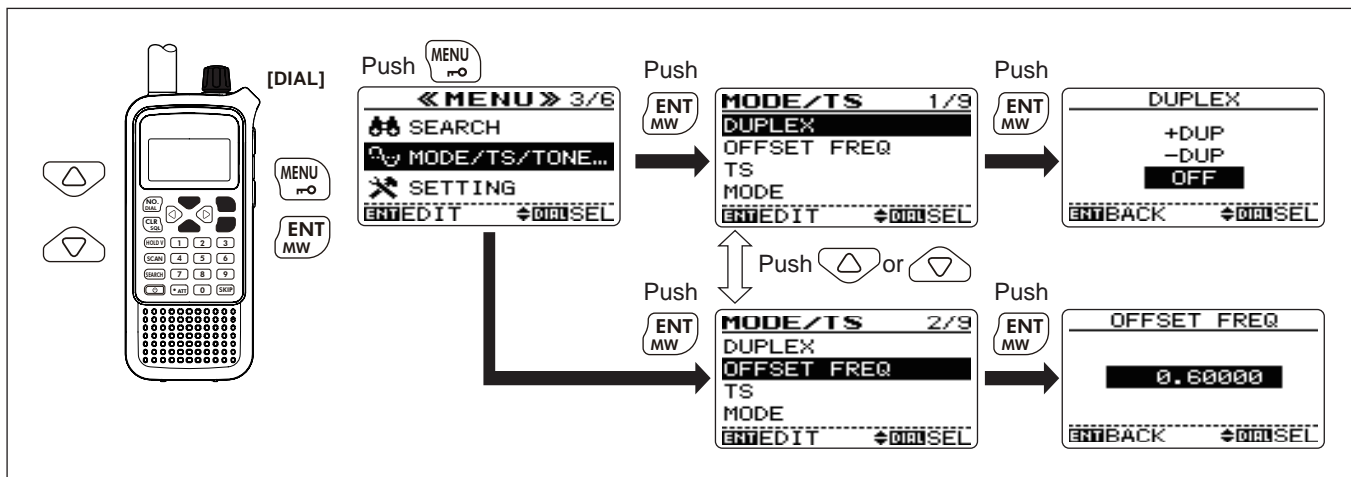



- ④ Push **[ENT MW]** (or **[<]**) to return to MODE/TS/TONE... menu, and push **[▽]** (or rotate **[DIAL]**) to select “OFFSET FREQ.”

MENU ⇨ MODE/TS/TONE... ⇨ **OFFSET FREQ** (p. 62)

- ⑤ Enter the desired offset frequency within 0.00000–159.99500 MHz range via the keypad, or by pushing **[△]/[▽]** (or rotate **[DIAL]**) also can be set.
- The tuning step, selected in VFO mode, is used for setting.
  - Push and hold **[<]** or **[>]** for 1 sec. then rotate **[DIAL]** to change the frequency in 1 MHz steps.
- ⑥ Push **[ENT MW]** (or **[<]**) to return to MODE/TS/TONE... menu, and push **[CLR SQL]** to return to frequency indication.

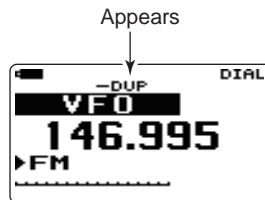

- ⑦ Push and hold **[CLR SQL]** to monitor the transmit station frequency (repeater input frequency) directly.

## ■ [DIAL] function assignment

The **[DIAL]** control can be used as an audio volume control instead of **[△]/[▽]** keys to suit your preference. However, while **[DIAL]** functions as an audio volume, **[△]/[▽]** keys function as tuning controls.

- Push and hold **[NO. DIAL]** for 1 sec. to toggle the dial function between tuning dial and audio volume.

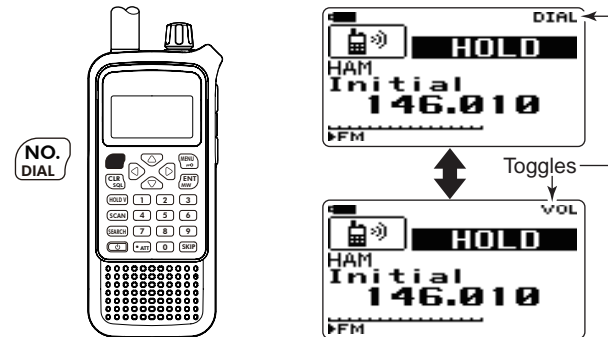

- The following functions are switched between **[DIAL]** and **[△]/[▽]**.

<b>[DIAL]</b>	<b>[△]/[▽]</b>
Frequency, Memory channel, Squelch level, Searching/Scanning direction	Audio volume set

## ■ Tone/DTCS squelch operation

### ◇ Tone and DTCS squelches

The tone squelch (CTCSS) or DTCS squelch opens only when receiving a signal containing a matching subaudible tone or DTCS code, respectively. You can silently wait for calls from group members using the same tone or code.

### ◇ Reverse tone/DTCS squelch

The reverse tone/DTCS squelch is convenient if you want to ignore a specific signal. The receiver mutes the squelch when a signal with the matched tone or code is received. "TSQL-R" / "DTCS-R" is displayed when the reverse tone/DTCS is set.

### ◇ Pocket beep

These functions use subaudible tones or DTCS codes for calling and can be used as a "common pager" to inform you that someone has called while you were away from the receiver.

### ◇ Setting

- ① Set the desired operating frequency in FM mode.
- ② Enter "TONE" in MODE/TS/TONE... menu.

MENU ⇨ MODE/TS/TONE... ⇨ **TONE** (p. 64)  
 (Push [MENU] ) , (Push [Δ]/[▽] ), then push [ENT MW].)

- ③ Push [Δ]/[▽] (or rotate [DIAL]) to select the tone or DTCS squelch.

- Tone squelch "TSQL," tone squelch reverse "TSQL-R," pocket beep "TSQL (·)," DTCS squelch "DTCS," DTCS squelch reverse "DTCS-R," DTCS beep "DTCS (·)" and no tone operation are available.

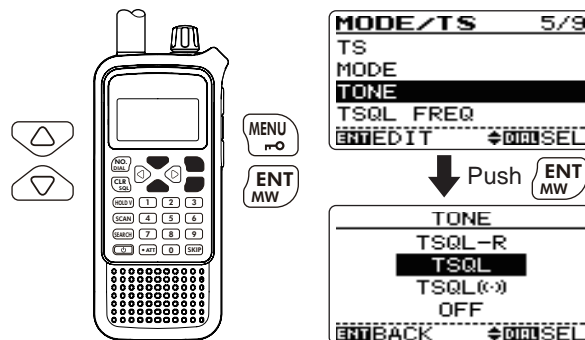

- ④ Push **[ENT MW]** (or **[<|]**) to return to MODE/TS/TONE... menu, and push **[CLR SQL]** to return to frequency indication.

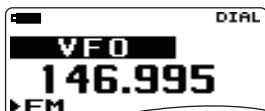

OFF (no indication)

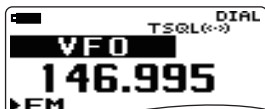

Tone squelch with pocket beep DTCS squelch with pocket beep

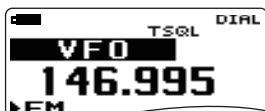
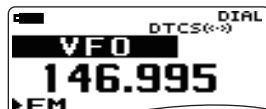

Tone squelch

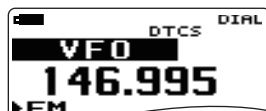

DTCS squelch

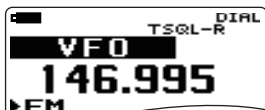

Tone squelch reverse

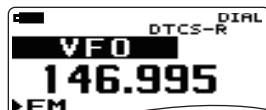

DTCS squelch reverse

- ⑤ Operate the receiver in the normal way.
- ⑥ When the received signal includes a matching tone/code, the squelch opens and the signal can be heard.
- When the received signal's tone/code does not match, tone/DTCS squelch does not open, however, the S-indicator shows signal strength.
  - To open the squelch manually, push and hold **[CLR SQL]** for 1sec.

### ◇ Pocket beep function

- ① When pocket beep function is activated and the signal with a matching tone/code is received, the receiver emits beep tones for 30 sec. and blinks "(··)".
- ② Push **[CLR SQL]** to stop the beeps and blinking.

## ■ Tone squelch frequency/DTCS code setting

- ① Enter “TSQL FREQ” or “DTCS CODE” in MODE/TS/TONE... menu for selecting tone squelch frequency or DTCS code, respectively.

MENU ⇨ MODE/TS/TONE... ⇨ **TSQL FREQ** (p. 64)  
 (Push [MENU ]), (Push [Δ]/[∇]), then push [ENT MW].)

MENU ⇨ MODE/TS/TONE... ⇨ **DTCS CODE** (p. 65)

- ② Push [Δ]/[∇] (or rotate [DIAL]) to select the desired tone squelch frequency or DTCS code.
- Each operating band and each memory channel have independent settings.
  - See next page for available tone frequencies or DTCS codes for details.

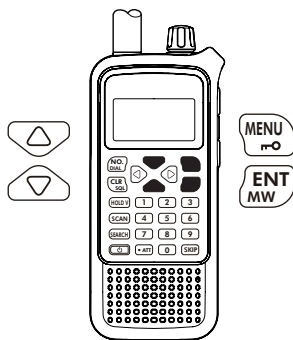

↓ Push [ENT MW]

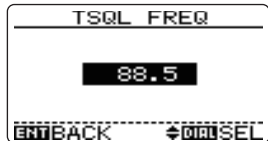

Tone squelch frequency

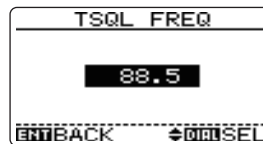

Tone squelch frequency

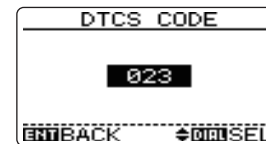

DTCS code

- ③ Push [ENT MW] (or [←]) to return to MODE/TS/TONE... menu, and push [CLR SQL] to return to frequency indication.

/// DTCS phase mode can be selected in “DTCS POLARITY” setting. (p. 81)

### •Available tone frequencies

67.0	79.7	94.8	110.9	131.8	156.7	171.3	186.2	203.5	229.1
69.3	82.5	97.4	114.8	136.5	159.8	173.8	189.9	206.5	233.6
71.9	85.4	100.0	118.8	141.3	162.2	177.3	192.8	210.7	241.8
74.4	88.5	103.5	123.0	146.2	165.5	179.9	196.6	218.1	250.3
77.0	91.5	107.2	127.3	151.4	167.9	183.5	199.5	225.7	254.1

### •Available DTCS code

023	054	125	165	245	274	356	445	506	627	732
025	065	131	172	246	306	364	446	516	631	734
026	071	132	174	251	311	365	452	523	632	743
031	072	134	205	252	315	371	454	526	654	754
032	073	143	212	255	325	411	455	532	662	
036	074	145	223	261	331	412	462	546	664	
043	114	152	225	263	332	413	464	565	703	
047	115	155	226	265	343	423	465	606	712	
051	116	156	243	266	346	431	466	612	723	
053	122	162	244	271	351	432	503	624	731	

## ■ DTCS polarity setting

- ① Enter "DTCS POLARITY" in MODE/TS/TONE... menu.

MENU ⇨ MODE/TS/TONE... ⇨ **DTCS POLARITY** (p. 65)  
(Push [MENU] ) , (Push [Δ]/[▽] , then push [ENT MW].)

- ② Push [Δ]/[▽] (or rotate [DIAL]) to select the desired DTCS polarity.

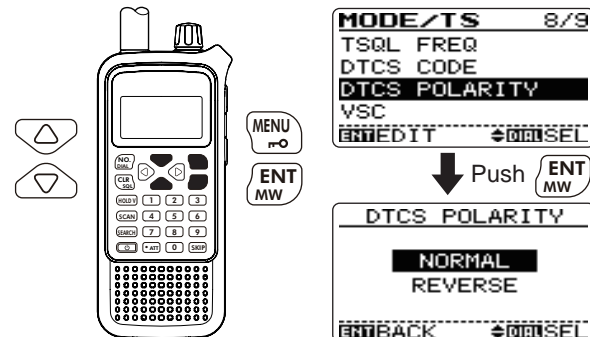

- ③ Push [ENT MW] (or [◀]) to return to MODE/TS/TONE... menu, and push [CLR SQL] to return to frequency indication.

## ■ Tone search

By monitoring a signal that is being operated with pocket beep, tone or DTCS squelch function, you can determine the tone frequency or DTCS code necessary to open a squelch.

① Set the frequency to be checked for a tone frequency or DTCS code.

② Enter "TONE SEARCH" in SEARCH menu.

MENU ⇨ SEARCH ⇨ **TONE SEARCH**  
 (Push [MENU] [M-O]), (Push [Δ]/[∇], then push [ENT MW].)

- SEARCH menu can also be entered by pushing and holding [SEARCH] for 1 sec.
- Tone search screen appears.

③ Push [Δ] or [∇] to select "TSQL" or "DTCS," then push [ENT MW] to start the tone search.

- To change the searching direction, rotate [DIAL].
- Tone squelch or DTCS squelch function is activated automatically.

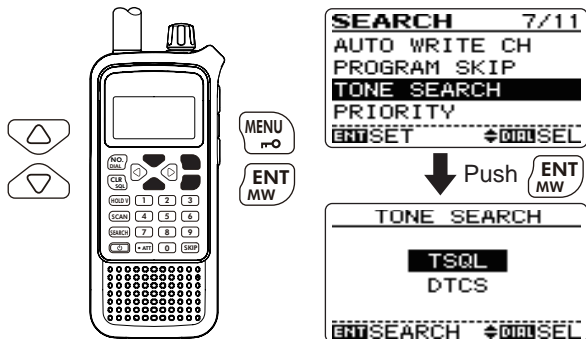

④ When the tone frequency or DTCS code is decoded, the setting menu contents are programmed with the frequency or code.

- The tone search pauses for the set period in search pause timer (p. 40) when a tone frequency or DTCS code is detected.
- The decoded tone frequency is used for the tone squelch frequency (TSQL FREQ) when the tone squelch is ON.
- The decoded DTCS code is used for the DTCS code when the DTCS squelch is ON.

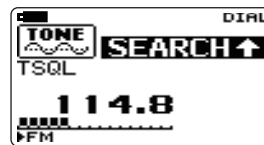

Tone search for tone squelch



Tone search for DTCS squelch

⑤ Push [CLR SQL] to stop the search.

- If the search is cancelled before the receiver detects the tone or code, the setting menu contents are not changed.
- The detected tone is used for temporary operation only. The stored tone setting in memory channel won't be changed.

**NOTE:** Tone frequency is over-written automatically when it corresponds with the searching tone frequency in tone squelch mode. However, it is not over-written in memory channel.

## ■ Beep tones

You can select to have confirmation beeps sound at the push of a switch. The output level can be adjusted within 40 levels with “BEEP LEVEL” in SOUNDS menu.

MENU ⇄ SOUNDS ⇄ **BEEP LEVEL** (p. 70)  
(Push [MENU ]), (Push [△]/[▽], then push [ENT MW].)

You can select silent operation by turning beep tones OFF with “KEY-TOUCH BEEP” in SOUNDS menu.

MENU ⇄ SOUNDS ⇄ **KEY-TOUCH BEEP** (p. 70)  
(Push [MENU ]), (Push [△]/[▽], then push [ENT MW].)

## ■ Dial speed acceleration

The dial speed acceleration automatically speeds up the tuning dial speed when rotating [DIAL] rapidly.

This function can be turned ON and OFF with “DIAL SPEED-UP” in SETTING menu.

MENU ⇄ SETTING ⇄ **DIAL SPEED-UP** (p. 68)  
(Push [MENU ]), (Push [△]/[▽], then push [ENT MW].)

## ■ Power save

The power save function reduces the current drain to conserve battery power.

The power save duty cycle, the ratio of receive circuit on to receive circuit off during standby, can be set to automatic (1 : 4 =125 msec. : 500msec., 1 : 8 =125 msec. : 1000 msec.) (default) or OFF with “POWER SAVE” in SETTING menu.

MENU ⇄ SETTING ⇄ **POWER SAVE** (p. 67)  
(Push [MENU ]), (Push [△]/[▽], then push [ENT MW].)

- “AUTO” selects “1:4” duty ratio when receiving no signal for 5 sec., then “1:8” 60 sec. after that.

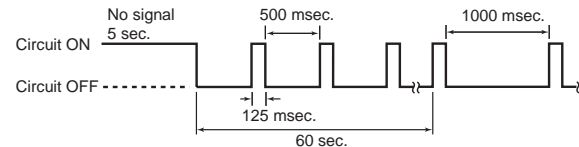

## 9 OTHER FUNCTIONS

### ■ Auto power OFF

The receiver can be set to automatically turn OFF after a specified period with a beep when no operation is performed.

120 min., 90 min., 60 min., 30 min. and OFF can be specified. The specified period is retained even when the receiver is turned OFF by the auto power-off function. To cancel the function, select "OFF" in the auto power-off item in SETTING menu.

This can be selected with "AUTO POWER OFF" in SETTING menu.



MENU ⇨ SETTING ⇨ **AUTO POWER OFF** (p. 67)  
(Push [MENU ]), (Push [Δ]/[▽]), then push [ENT MW].)

### ■ Auto power ON

The receiver can be set to automatically turn ON after passing the set time period from power OFF. The timer can be selected within 30 min. to 24 hrs. in 30 min. steps.

This can be selected with "AUTO POWER ON" in SETTING menu.

MENU ⇨ SETTING ⇨ **AUTO POWER ON** (p. 67)  
(Push [MENU ]), (Push [Δ]/[▽]), then push [ENT MW].)

 When operating with battery pack or case and the battery is exhausted, auto power-on does not function.  
 During standby, a small current still flows in the radio.

### ■ Display backlighting

The receiver has display backlighting with a 5 sec. timer for night time operation. The display backlighting can be turned ON continuously or turned OFF, if desired.

This can be selected with "BACKLIGHT" in DISPLAY menu.

MENU ⇨ DISPLAY ⇨ **BACKLIGHT** (p. 72)  
(Push [MENU ]), (Push [Δ]/[▽]), then push [ENT MW].)

### ■ Font size

Displayed character size for group/name during scan operations or category during basic search operation is selectable from Large and Small.

This can be selected with "FONT SIZE" in DISPLAY menu.

MENU ⇨ DISPLAY ⇨ **FONT SIZE** (p. 72)  
(Push [MENU ]), (Push [Δ]/[▽]), then push [ENT MW].)



## ■ LCD contrast

The contrast of the LCD can be selected from 15 levels.

This can be selected with “LCD CONTRAST” in DISPLAY menu.

MENU ⇨ DISPLAY ⇨ **LCD CONTRAST** (p. 72)  
 (Push [MENU ]), (Push [△]/[▽], then push [ENT MW].)

## ■ Voice squelch control

This function is useful when you don't want unmodulated signals pausing or cancelling a search/scan. When the voice squelch control function is activated, the receiver checks received signals for voice components. If a received signal includes voice components, and the tone of the voice components changes within 1 sec., search/scan pauses (or stops). If the received signal includes no voice components or the tone of the voice components does not change within 1 sec., scan resumes.

This can be selected with “VSC” in MODE/TS/TONE... menu.

MENU ⇨ MODE/TS/TONE... ⇨ **VSC** (p. 65)  
 (Push [MENU ]), (Push [△]/[▽], then push [ENT MW].)

- “VSC” appears when the function is activated.

## 9 OTHER FUNCTIONS

### ■ Cloning function

The IC-RX7 has receiver-to-receiver data cloning capability. This function is useful when you want to copy all of the programmed contents from one IC-RX7 to another.

- An optional OPC-474 CLONING CABLE is required.

- ① Turn the receiver's power OFF, then connect an optional OPC-474 between both [SP] jacks as below.

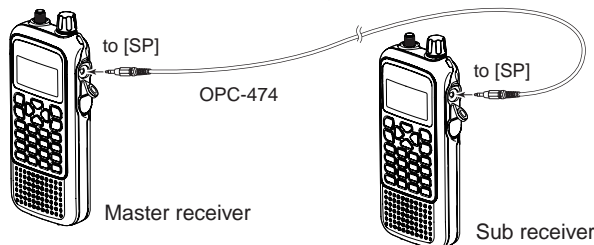

- ② **Master receiver:** While pushing and holding [ $\Delta$ ] and [MENU  $\rightarrow$  O], push and hold [POWER] for 1 sec. to enter cloning mode.

- "MASTER" appears.

**Sub receiver:** Push and hold [POWER] for 1 sec. to turn the receiver power ON. (See right below for more information.)

- ③ Push [ENT MW] on the "master" receiver.
  - "CLONE OUT" appears on the master receiver and "CLONE IN" appears on the sub receiver and the bar meters show that cloning is taking place.
  - After the cloning is completed, the display shows "CLONE END."
- ④ Push and hold [POWER] for 1 sec. to turn power OFF.

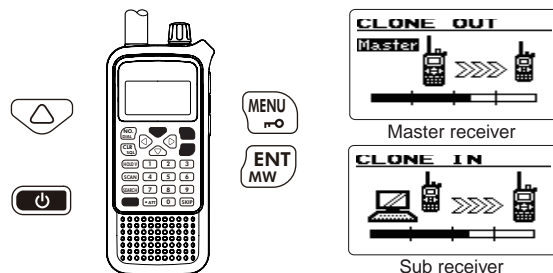

The optional CS-RX7 CLONING SOFTWARE is also available to clone/edit contents with a PC (for Microsoft® Windows® 2000/XP or Windows Vista™) and using ICF format files.

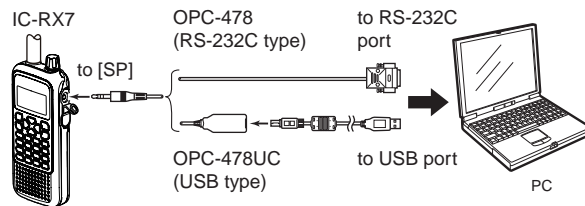

#### ✓ CLONING MODE ENTRY (except Master receiver):

When the CI-V baud rate (p. 69) is selected any other than "9600" or "AUTO," the following operations are required.

- ① Turn the receiver's power OFF.
- ② While pushing and holding [SCAN], push and hold [POWER] for 1 sec. to enter cloning mode.

## ■ Resetting

The display may occasionally display erroneous information (e.g. when first applying power). This may be caused externally by static electricity or by other factors.

If this problem occurs, turn power OFF. After waiting a few seconds, turn power ON again. If the problem persists, perform either or both procedures below.



### • All reset

Reset the CPU before operating the receiver for the first time, or if the internal CPU malfunctions, to clear and return all programmed contents to their default settings. (Basic search does not clear.)

### • Partial reset

If you want to initialize the operating conditions (VFO frequency, VFO settings, set mode contents) without clearing the memory contents and basic search, a partial reset function is available for the receiver.

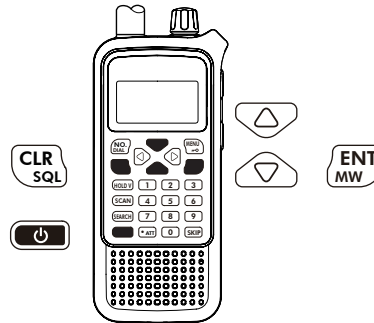

### ◇ All reset

- ① Push and hold  for 1 sec. to turn power OFF.
- ② While pushing and holding [, [, [**ENT MW**] and [**CLR SQL**], turn power ON to reset the CPU.
  - “ALL RESET” appears when resetting the CPU (See the illustration below).



**CAUTION:** Resetting the CPU returns all programmed contents to their default settings. Any memory channel settings or other customized settings will be lost. To help prevent such an inconvenience, optional CS-RX7 is available to back up favorite settings and memory channel information.

### ◇ Partial reset

- ① Push and hold  for 1 sec. to turn power OFF.
- ② While pushing and holding [, [, turn power ON to partially reset the receiver.

**NOTE:** No message appears on the display after the partial reset is done.

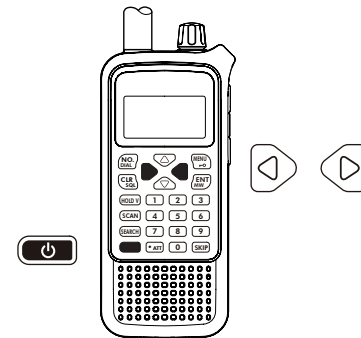

# 10 CONTROL COMMAND

## ■ General

The IC-RX7 can be connected to a PC via the PC's RS-232C port using an optional CT-17 CI-V LEVEL CONVERTER. This allows you to control the receiver from the PC and/or transfer data from the receiver to the PC.

Control is provided via Icom's CI-V Communication Interface.

/// An appropriate application for CI-V command is not supplied from Icom.

## ■ Data format

The CI-V system can be operated using the following data formats. Data formats differ according to command numbers. A data area is added for some commands.

### Controller → IC-RX7

FE	FE	78	E0	Cn	Sc	Data area	FD
①	②	③	④	⑤	⑥	⑦	

### IC-RX7 → Controller

FE	FE	E0	78	Cn	Sc	Data area	FD
①	③	②	④	⑤	⑥	⑦	

- ① Preamble code (fixed)
- ② Receiver's default address
- ③ Controller's default address
- ④ Command number (see table below)
- ⑤ Sub command number (see table below)
- ⑥ BCD code data for frequency/mode/Squelch condition entry
- ⑦ End of message code (fixed)

## ■ Command table

Description	Cn	Sc
Transfers frequency data (transceive)	00	—
Transfers mode data (transceive)	01	—
Reads display frequency	03	—
Reads display mode	04	—
Sets frequency data	05	—
Sets AM mode	06	02
Sets FM mode		05
Sets WFM mode		06
Reads squelch condition (open or closed)	15	01
Reads S-meter level		02

## CI-V connections example

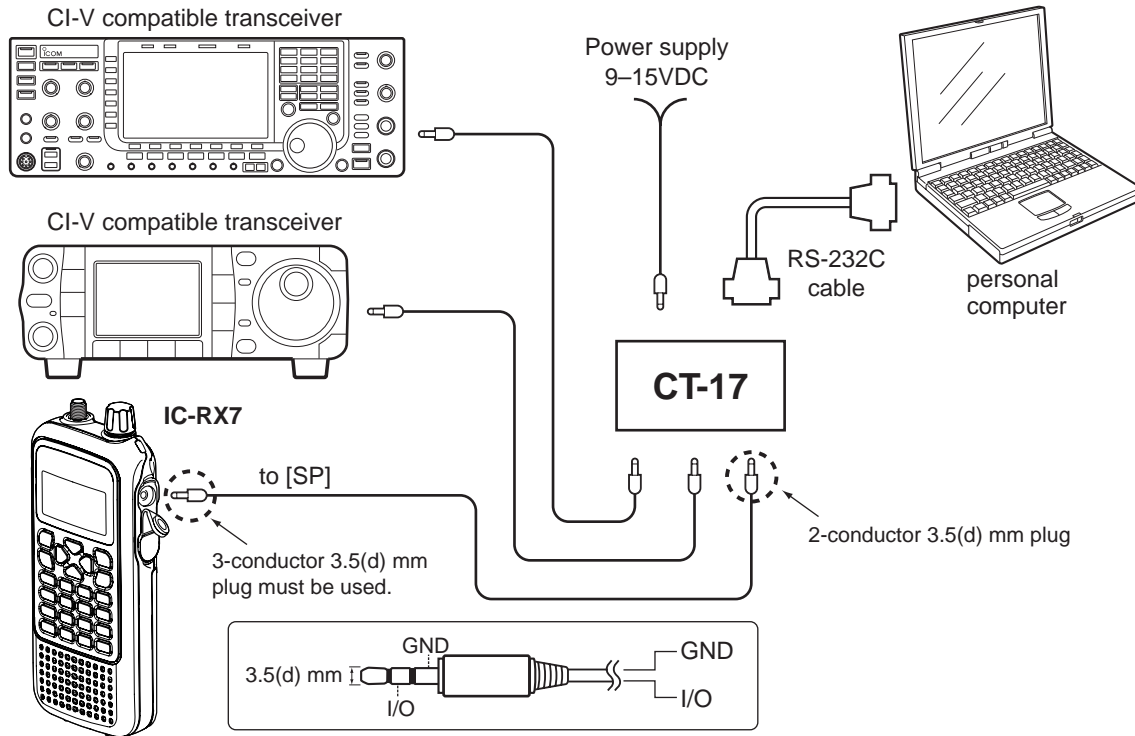

# 11 TROUBLESHOOTING

If your receiver seems to be malfunctioning, please check the following points before sending it to a service center.

PROBLEM	POSSIBLE CAUSE	SOLUTION	REF.
No power comes ON.	<ul style="list-style-type: none"> <li>• The battery pack or batteries is/are exhausted.</li> <li>• Loose connection of a battery pack (case).</li> <li>• The battery polarity is reversed.</li> </ul>	<ul style="list-style-type: none"> <li>• Charge the battery pack or replace the batteries.</li> <li>• Clean battery terminals.</li> <li>• Check the battery polarity.</li> </ul>	<p>pgs. 2, 3, 12</p> <p>–</p> <p>–</p>
No sound comes from the speaker.	<ul style="list-style-type: none"> <li>• Volume level is too low.</li> <li>• External speaker or Cloning cable is connected to [SP] jack.</li> <li>• Squelch level is set too tight.</li> <li>• Different tone is selected with tone/DTCS squelch.</li> </ul>	<ul style="list-style-type: none"> <li>• Push [△] to suitable level.</li> <li>• Check the connection of the external speaker correctly or disconnect the cloning cable.</li> <li>• After pushing and holding [CLR SQL] for 1 sec., rotate [DIAL] to set the squelch level.</li> <li>• Turn the appropriate function OFF.</li> </ul>	<p>p. 14</p> <p>–</p> <p>p. 15</p> <p>p. 78</p>
Sensitivity is low and only strong signals are audible.	<ul style="list-style-type: none"> <li>• The attenuator function is activated.</li> <li>• RF gain is setting too low.</li> </ul>	<ul style="list-style-type: none"> <li>• Push and hold [• ATT] for 1 sec. to cancel the function.</li> <li>• Set the RF gain to “MAX” in SETTING menu.</li> </ul>	<p>p. 75</p> <p>p. 74</p>
Receive audio is distorted.	<ul style="list-style-type: none"> <li>• Receiving mode is not selected correctly.</li> <li>• The battery pack or batteries is/are almost exhausted.</li> </ul>	<ul style="list-style-type: none"> <li>• Set the receiving mode correctly in MODE/TS/TONE... menu.</li> <li>• Charge the battery pack or replace the batteries.</li> </ul>	<p>p. 19</p> <p>pgs. 2, 3, 12</p>
Frequency can not be set.	<ul style="list-style-type: none"> <li>• The lock function is activated.</li> </ul>	<ul style="list-style-type: none"> <li>• Push [MENU ] for 1 sec. to cancel the function.</li> </ul>	<p>p. 75</p>
Key operation cannot work	<ul style="list-style-type: none"> <li>• The monitor function is activated.</li> </ul>	<ul style="list-style-type: none"> <li>• Push [CLR SQL] to cancel the function.</li> </ul>	<p>p. 15</p>
Scan function cannot start.	<ul style="list-style-type: none"> <li>• The programmed memory channel is only one.</li> </ul>	<ul style="list-style-type: none"> <li>• Program more than 2 memory channels.</li> </ul>	<p>pgs. 50–55</p>
Link scan function cannot start.	<ul style="list-style-type: none"> <li>• All category or group are set to “SKIP.”</li> </ul>	<ul style="list-style-type: none"> <li>• Cancel “SKIP” setting in SCAN menu.</li> </ul>	<p>p. 45</p>
Frequency band cannot be changed during search	<ul style="list-style-type: none"> <li>• Search direction and [◀] (or [▶]) key operation is opposite</li> </ul>	<ul style="list-style-type: none"> <li>• Rotate [DIAL] to change the searching direction, or push another key to change the frequency band.</li> </ul>	<p>p. 18</p>
The displayed frequency is erroneous.	<ul style="list-style-type: none"> <li>• The CPU malfunctioned.</li> <li>• External factors caused a fault.</li> </ul>	<ul style="list-style-type: none"> <li>• Reset the receiver.</li> <li>• Remove and re-attach the battery pack or battery case.</li> </ul>	<p>p. 87</p> <p>pgs. 2, 3</p>

## ◇ General

- Frequency coverage : (Unit: MHz)
  - USA : 0.150–821.995, 851.000–866.995, 896.000–1300.000
  - Other than USA : 0.150–1300.000
- Number of memory channels : 1600 channels (Memory channels)  
200 channels (Auto write channels)  
25 channels (Program edge channels)
- Receive modes : FM, AM, WFM
- Frequency resolution : 5, 6.25, 7.5, \*8.33,\*9, 10, 12.5, 15, 20, 25, 30, 50, 100, 125, 200 kHz  
\*selectable depending on the operating frequency band.
- Operating temperature range : –10°C to +60°C; +14°F to +140°F
- Reference frequency stability : ±6 ppm (–10°C to +60°C; +14°F to +140°F)
- Power supply requirement : BP-244 (Li-Ion battery pack),  
(Negative ground) BP-262 (3 AA (LR6) alkaline cells) or  
5.1 to 6.9 V DC (with CP-18A/E)
- Current drain (backlight OFF with BP-244 (3.7 V DC):
  - rated audio : 150 mA typical
  - receive standby : 100 mA typical
  - power saved : 35 mA typical
- Antenna connector type : SMA
- Antenna impedance : 50 Ω (unbalanced)
- Dimensions (proj. not included) : 57(W) × 128(H) × 23(D) mm  
2¼(W)×5½(H)×29½(D) in
- Weight (approx.) : 200 g; 7.1 oz (with the ant. and BP-244)
- AF output power (at 3.7 V DC) : More than 60 mW at 70% modulation,  
10% distortion with an 8 Ω load
- Ext. speaker connector : 3-conductor 3.5 (d) mm (1/8")/8 Ω

## ◇ Receiver

- Receive system : Triple-conversion superheterodyne
- Intermediate frequencies : 1st : 429.1 MHz  
2nd : 19.65 MHz (FM/AM),  
20.75 MHz (WFM)  
3rd : 450 kHz (FM/AM),  
1.55 MHz (WFM)
- Sensitivity (except spurious points) :
  - FM (1 kHz/3.5 kHz Dev.; 12 dB SINAD)
    - 1.625–4.995 MHz : Less than 0.56 μV
    - 5.000–246.995 MHz : Less than 0.4 μV
    - 247.000–832.995 MHz : Less than 0.56 μV
    - 833.000–1300.000 MHz : Less than 0.79 μV (Except USA version)
    - 851.000–866.995 MHz : Less than 1.3 μV (USA version only)
    - 896.000–1300.000 MHz : Less than 0.79 μV (USA version only)
  - WFM (1 kHz/52.5 kHz Dev.; 12 dB SINAD)
    - 76.000–108.000 MHz : Less than 1.8 μV
    - 175.000–221.995 MHz : Less than 1.8 μV
    - 470.000–770.000 MHz : Less than 2.5 μV
  - AM EXT-ANT (DX) (1 kHz/30% MOD.; 10 dB S/N)
    - 0.495–4.995 MHz : Less than 2.5 μV
    - 5.000–29.995 MHz : Less than 1.8 μV
    - 118.000–136.000 MHz : Less than 1.8 μV
    - 222.000–246.995 MHz : Less than 1.8 μV
    - 247.000–329.995 MHz : Less than 1.8 μV
- Selectivity :
  - AM/FM : More than 15 kHz/–9 dB  
Less than 30 kHz/–60 dB
  - WFM : More than 150 kHz/–6 dB

All stated specifications are subject to change without notice or obligation.

# 13 OPTIONS

## BC-149 A/D AC ADAPTOR



For charging of the attached battery pack (BP-244). 6 V DC/1 A output. Same as supplied. (Not supplied with some versions.)

## CP-18A/E CIGARETTE LIGHTER CABLE WITH DC-DC CONVERTER



Allows you to operate the receiver through a 12 V cigarette lighter socket, and also charges the attached battery pack (BP-244). A built-in DC-DC converter outputs 6 V DC.

## SP-13 EARPHONE



Provides clear receive audio in noisy environments.

## CS-RX7 CLONING SOFTWARE with OPC-478UC CLONING CABLE (USB type)

Allows you to transfer data, such as memories, and quickly and easily edit and store data via a PC (for Microsoft® Windows® 2000/XP or Windows Vista™) with an USB (1.1/2.0) port. A cloning cable, OPC-478UC, is supplied with the software.

## OPC-478/UC CLONING CABLE (RS-232C type)/(USB type)

**OPC-474** CLONING CABLE  
Used for receiver -to-receiver cloning

**MB-112G** BELT CLIP  
Same as supplied.

**BP-244** Li-Ion BATTERY PACK  
3.7 V/1100 mAh Lithium Ion battery pack. Same as supplied.

**BP-262** BATTERY CASE  
Battery case for LR6 (AA) × 3 alkaline batteries.

**CT-17** CI-V LEVEL CONVERTER  
For receiver remote control using a PC.

**AD-92SMA**  
ANTENNA CONNECTOR ADAPTER  
Allows you to connect an external antenna with a BNC connector.

**LC-170** CARRYING CASE  
Helps protect the receiver from scratches, etc.

**HP-4**  
HEAD PHONE  
Provides clear receive audio in noisy environments.





We Icom Inc. Japan  
1-1-32, Kamiminami, Hirano-ku  
Osaka 547-0003, Japan

Declare on our sole responsibility that this equipment complies with the essential requirements of the Radio and Telecommunications Terminal Equipment Directive, 1999/5/EC, and that any applicable Essential Test Suite measurements have been performed.

**Kind of equipment:** **WIDEBAND RECEIVER**

**Type-designation:** **IC-RX7**

**Version (where applicable):**

This compliance is based on conformity with the following harmonised standards, specifications or documents:

- i) EN 301 489-1 V1.4.1. (August 2002)
- ii) EN 301 489-15 V1.2.1. (August 2002)
- iii) EN 301 783-2 V1.1.1. (September 2000)
- iv) EN 60950-1: 2001: A11: 2004

## DECLARATION OF CONFORMITY



Düsseldorf 23rd Jun. 2008  
Place and date of issue

Icom (Europe) GmbH  
Himmelgeister straÙe 100  
D-40225 Düsseldorf  
Authorized representative name

Y. Furukawa  
General Manager

Signature

**Icom Inc.**

---

# 14 CE

## • List of Country codes (ISO 3166-1)

	Country	Codes		Country	Codes
1	Austria	AT	18	Liechtenstein	LI
2	Belgium	BE	19	Lithuania	LT
3	Bulgaria	BG	20	Luxembourg	LU
4	Croatia	HR	21	Malta	MT
5	Czech Republic	CZ	22	Netherlands	NL
6	Cyprus	CY	23	Norway	NO
7	Denmark	DK	24	Poland	PL
8	Estonia	EE	25	Portugal	PT
9	Finland	FI	26	Romania	RO
10	France	FR	27	Slovakia	SK
11	Germany	DE	28	Slovenia	SI
12	Greece	GR	29	Spain	EP
13	Hungary	HU	30	Sweden	SE
14	Iceland	IS	31	Switzerland	CH
15	Ireland	IE	32	Turkey	TR
16	Italy	IT	33	United Kingdom	GB
17	Latvia	LV			

– A –

AF filter (AF FILTER) ..... 70  
 All reset ..... 87  
 All scan ..... 42  
 AM antenna selection (AM ANTENNA) ..... 66  
 Antenna ..... 1  
 Antenna selection ..... 73  
 Attenuator function ..... 75  
 Auto power OFF (AUTO POWER OFF) ..... 67, 84  
 Auto power ON (AUTO POWER ON) ..... 67, 84  
 Auto write search ..... 34  
 Available DTCS code ..... 81  
 Available frequency bands ..... 17  
 Available tone frequencies ..... 81

– B –

Band search ..... 27  
 Basic search ..... 26  
 Bass level (BASS) ..... 71  
 Battery caution ..... 10  
 Battery indicator ..... 12, 13  
 Battery information ..... 3, 13  
 Battery installation ..... 2  
 Battery life ..... 13  
 Battery replacement ..... 3  
 Beep output level (BEEP LEVEL) ..... 70  
 Beep tones ..... 83  
 Belt clip ..... 1

BP-244 installation ..... 2  
 BP-262 installation ..... 3

– C –

Category scan ..... 42  
 Caution ..... 10  
 CE ..... 93  
 Changing memory contents (EDIT) ..... 57  
 Channel skip setting ..... 46  
 Charging ..... 12  
 Charging caution ..... 11  
 Charging indicator ..... 12  
 Charging note ..... 12  
 CI-V address (ADDRESS) ..... 69  
 CI-V baud rate (BAUD RATE) ..... 69  
 CI-V setting (CI-V SET) ..... 69  
 CI-V transceive (TRANSCIVE) ..... 69  
 Clearing memory contents (CLEAR) ..... 58  
 Clearing search edges (CLEAR) ..... 31  
 Cloning function ..... 86  
 Command table (CI-V) ..... 88  
 CONTROL COMMAND (CI-V) ..... 88  
 Copying memory contents (COPY) ..... 56  
 CP-18A/E fuse replacement ..... 13

– D –

Data format (CI-V) ..... 88  
 Dial acceleration (DIAL SPEED-UP) ..... 68

# INDEX

Dial speed acceleration .....	83
[DIAL] function assignment.....	77
Direct frequency entry .....	20
DIRECT KEY .....	51, 52, 53
Display backlighting (BACKLIGHT) .....	72, 84
DISPLAY menu.....	61
DISPLAY menu items .....	72
DTCS code (DTCS CODE) .....	65
DTCS code setting .....	80
DTCS polarity (DTCS POLARITY).....	65
DTCS polarity setting.....	81
DTCS squelch operation .....	78
DTCS squelch setting (TONE).....	64
Duplex direction (DUPLEX) .....	62
Duplex operation .....	76

## – E –

Entering MENU screen and operation.....	59
EXPLICIT DEFINITIONS.....	i
External DC power operation .....	13

## – F –

FCC INFORMATION .....	iii
FEATURES.....	i
FM antenna selection (FM ANTENNA) .....	66
Font size .....	84
Font size (FONT SIZE).....	72
FOREWORD .....	i
Front panel.....	4

Full search .....	26
Function display.....	7

## – G –

General (CI-V) .....	88
General (MENU screen) .....	59
General description .....	49
Group scan .....	43
Group skip setting .....	46

## – H –

Hand strap .....	2
------------------	---

## – I –

IMPORTANT .....	i
-----------------	---

## – K –

Key lock type (LOCK) .....	68
KEYPAD .....	5
Key-touch beep (KEY-TOUCH BEEP) .....	70

## – L –

LCD contrast (LCD CONTRAST) .....	72, 85
Link scan .....	41
Lock function .....	75

## – M –

Memory category programming .....	52
Memory CH (channel) programming .....	55
Memory channel contents .....	49

Memory channel programming.....50  
 Memory channel selection.....55  
 Memory channel watch.....38  
 Memory channel watch during search.....39  
 Memory group programming .....53  
 Memory name programming .....54  
 Memory organization.....49  
 Menu list .....60  
 MENU SCREEN OPERATION .....59  
 MHz tuning step mode.....22  
 MODE/TS/TONE menu items.....62  
 MODE/TS/TONE menu .....61  
 Monitor function.....15

– O –

Offset frequency (OFFSET FREQ).....62  
 Opening logo (OPENING LOGO).....72  
 Operating band selection.....16  
 Operating mode selection.....16  
 Operating note.....13  
 OPERATING NOTES.....iv  
 OPERATING THEORY .....iv  
 Optional battery case .....3  
 OPTIONS .....92  
 Other SCAN menu items .....48  
 Other SEARCH menu items .....40

– P –

Partial reset .....87  
 Pocket beep function .....78, 79  
 Power ON .....14  
 Power save (POWER SAVE).....67, 83  
 PRECAUTIONS.....ii  
 Priority scan .....47  
 Priority watch.....37  
 Priority watch types .....37  
 Program link programming .....32  
 Program link search.....29  
 Program search .....28  
 Receiving mode (MODE).....63  
 Receiving mode selection.....19  
 Resetting .....87  
 Reverse DTCS squelch .....78  
 Reverse Tone squelch .....78  
 RF gain (RF GAIN).....67, 74

– S –

SCAN menu.....60  
 Scan mode .....18  
 Scan pause timer (PAUSE).....48  
 Scan resume timer (RESUME).....48  
 Scan watch during search .....39  
 Search and scan types.....24  
 Search edges programming (EDIT) .....30  
 SEARCH menu.....60  
 Search mode .....18

---

## INDEX

Search pause timer (PAUSE) .....	40
Search resume timer (RESUME) .....	40
Selecting antenna .....	73
Setting a frequency .....	20
Setting a tuning step .....	23
Setting audio volume .....	14
Setting frequency via the dial .....	22
Setting frequency via the keypad .....	20
SETTING menu .....	61
SETTING menu items .....	66
Setting squelch level .....	15
Side panel .....	4
Skip search .....	36
Skip setting for scanning .....	45
SOUNDS menu .....	61
SOUNDS menu items .....	70
SPECIFICATIONS .....	91
Stop beep (STOP BEEP) for scan .....	48
Stop beep (STOP BEEP) for search .....	40
SUPPLIED ACCESSORIES .....	iii

### – T –

TABLE OF CONTENTS .....	v
Tone control (TONE CONTROL) .....	71
Tone search (TONE SEARCH) .....	82
Tone squelch frequency (TSQL FREQ) .....	64
Tone squelch frequency setting .....	80
Tone squelch operation .....	78
Tone squelch/DTCS squelch setting (TONE) .....	64

Top panel .....	4
Treble level (TREBLE) .....	71
TROUBLESHOOTING .....	90
Tuning step (TS) .....	63
Tuning step selection .....	23

### – V –

VFO mode .....	16
Voice squelch control .....	85
Voice squelch control (VSC) .....	65

### – W –

Weather alert function .....	44
Weather channel operation .....	44
Weather channel selection .....	44

# Count on us!

#02 EUR-01

<Intended Country of Use>											
<input checked="" type="checkbox"/>	AT	<input checked="" type="checkbox"/>	BE	<input checked="" type="checkbox"/>	CY	<input checked="" type="checkbox"/>	CZ	<input checked="" type="checkbox"/>	DK	<input checked="" type="checkbox"/>	EE
<input checked="" type="checkbox"/>	FI	<input checked="" type="checkbox"/>	FR	<input checked="" type="checkbox"/>	DE	<input checked="" type="checkbox"/>	GR	<input checked="" type="checkbox"/>	HU	<input type="checkbox"/>	IE
<input checked="" type="checkbox"/>	IT	<input checked="" type="checkbox"/>	LV	<input checked="" type="checkbox"/>	LT	<input checked="" type="checkbox"/>	LU	<input checked="" type="checkbox"/>	MT	<input checked="" type="checkbox"/>	NL
<input checked="" type="checkbox"/>	PL	<input checked="" type="checkbox"/>	PT	<input checked="" type="checkbox"/>	SK	<input checked="" type="checkbox"/>	SI	<input checked="" type="checkbox"/>	ES	<input checked="" type="checkbox"/>	SE
<input type="checkbox"/>	GB	<input checked="" type="checkbox"/>	IS	<input checked="" type="checkbox"/>	LI	<input checked="" type="checkbox"/>	NO	<input checked="" type="checkbox"/>	CH	<input checked="" type="checkbox"/>	BG
<input checked="" type="checkbox"/>	RO	<input checked="" type="checkbox"/>	TR	<input checked="" type="checkbox"/>	HR						

#03 UK-01

<Intended Country of Use>											
<input type="checkbox"/>	AT	<input type="checkbox"/>	BE	<input type="checkbox"/>	CY	<input type="checkbox"/>	CZ	<input type="checkbox"/>	DK	<input type="checkbox"/>	EE
<input type="checkbox"/>	FI	<input type="checkbox"/>	FR	<input type="checkbox"/>	DE	<input type="checkbox"/>	GR	<input type="checkbox"/>	HU	<input checked="" type="checkbox"/>	IE
<input type="checkbox"/>	IT	<input type="checkbox"/>	LV	<input type="checkbox"/>	LT	<input type="checkbox"/>	LU	<input type="checkbox"/>	MT	<input type="checkbox"/>	NL
<input type="checkbox"/>	PL	<input type="checkbox"/>	PT	<input type="checkbox"/>	SK	<input type="checkbox"/>	SI	<input type="checkbox"/>	ES	<input type="checkbox"/>	SE
<input checked="" type="checkbox"/>	GB	<input type="checkbox"/>	IS	<input type="checkbox"/>	LI	<input type="checkbox"/>	NO	<input type="checkbox"/>	CH	<input type="checkbox"/>	BG
<input type="checkbox"/>	RO	<input type="checkbox"/>	TR	<input type="checkbox"/>	HR						

A-6685D-1EX  
Printed in Japan  
© 2008 Icom Inc.

Printed on recycled paper with soy ink.

**Icom Inc.**

1-1-32 Kamiminami, Hirano-ku, Osaka 547-0003, Japan